



TAL 042

Low Voltage Alternator - 4 pole

Three-phase 25 to 60 kVA - 50 Hz / 31.5 to 75 kVA - 60 Hz
Dedicated single-phase 18 to 42 kVA - 50 Hz / 23 to 53 kVA - 60 Hz
Electrical and mechanical data

LEROY-SOMER[™]

IMC | INTERNATIONAL
MACHINERY
& GENERATORS

Nidec
All for dreams

TAL 042 - Three-phase & Single-phase

Adapted to needs

The TAL alternator range is designed to meet the needs of general applications such as prime power and stand-by.

Compliant with international standards

The TAL range complies with international standards and regulations: IEC 60034 and derivative.

The range is designed, manufactured and marketed in an ISO 9001 and 14001 environment.

Electrical design

- Class H insulation
- Shunt excitation
- Low voltage winding:
 - Three-phase 50 Hz: 380V - 400V - 415V - 440V / 220V - 230V - 240V
 - 60 Hz: 380V - 416V - 440V - 480V / 220V - 208V - 240V
- Single-phase 50 Hz: 115V - 230V
- 60 Hz: 120V - 240V
- 4-terminal plates in 6-wire version
- Optimized performance

Robust design

- Compact and rugged assembly to withstand engine vibrations
- Steel frame
- Aluminum flanges and shields
- Single bearing design compatible with most diesel engines
- Sealed for life single bearing
- Direction of rotation: clockwise and counterclockwise without derating



Excitation and regulation system suited to the application

	Excitation system				Regulation options	
	AVR	Shunt	AREP	PMG	ULc/US	Remote voltage potentiometer
Three-phase 6-wire	R120	Standard				
	R150	Option				√
	R180		Standard	Standard		√
	R438		Option	Option	√	√
Three-phase 12-wire	R120	Standard				
	R220	Option			√	√
	R180		Standard	Standard		√
	R438		Option	Option	√	√
Single-phase	R121	Standard				√
	R221	Option			√	√

√: Possible option

Compact terminal box

- Easy access to AVR and terminals

Environment and protection

- IP Code IP 23
- Standard winding protection for non-harsh environment with relative humidity ≤ 95%

Available options

- Three-phase 12-wire with 8-terminal plates
- Excitation AREP & PMG with auxiliary winding
- ULc/us
- Customized painting (machine not painted as standard)
- Space heaters
- Flying leads
- Dedicated single-phase
- Winding 8 optimized for three-phase 380V / 416V - 60Hz
- Winding protection for harsh environments and relative humidity greater than 95% (system 2 - 4): derating according to the following table

	50 Hz			60 Hz
Type	380 V	400 V	415 V	All voltages
TAL 042	0.97	1 except 0.97 for TAL 042 G & H	1 except 0.97 for TAL 042 G & H	1 except 0.97 for TAL 042 G & H

TAL 042 - Three-phase 25 to 60 kVA - 50 Hz / 31.5 to 75 kVA - 60 Hz

General characteristics

Insulation class	H	Excitation system 6-wire	SHUNT	AREP
Winding pitch	2/3 (wind.6S - 6-wire / wind.6 - 12-wire)	AVR type	R120	R180
Number of wires	6-wire (12-wire option)	Excitation system 12-wire (option)	SHUNT	AREP
Protection	IP 23	AVR type	R120	R180
Altitude	≤ 1000 m	Voltage regulation (*)		± 1 %
Overspeed	2250 R.P.M.	Total Harmonic Distortion THD (**) in no-load		< 2 %
Air flow 50 Hz (m³/s)	0.10	Total Harmonic Distortion THD (**) in linear load		< 5 %
Air flow 60 Hz (m³/s)	0.13	Waveform: NEMA = TIF (**)		< 50
AREP Short-circuit current = 2.7 In: 5 second		Waveform: I.E.C. = FHT (**)		< 2%

(*) Steady state (**) Total harmonic distortion between phases, no-load or on-load (non-distorting)

Ratings 50 Hz - 1500 R.P.M.

kVA / kW - P.F. = 0.8																					
Duty / T° C		Continuous / 40 °C					Continuous / 40 °C					Stand-by / 40 °C				Stand-by / 27 °C					
Class / T° K		H / 125° K					F / 105° K					H / 150° K				H / 163° K					
Phase		3 ph.			1 ph.		3 ph.			1 ph.		3 ph.		1 ph.		3 ph.			1 ph.		
Y		380V	400V	415V	440V		380V	400V	415V	440V		380V	400V	415V	440V		380V	400V	415V	440V	
Δ		220V	230V	240V		230V	220V	230V	240V		230V	220V	230V	240V		230V	220V	230V	240V		230V
YY (*)		220V					220V					220V					220V				
ΔΔ (*)						230V					230V					230V					230V
TAL 042 A	kVA	25	25	25	24.5	15	23	23	23	22.5	13.5	26.5	26.5	26.5	26	16	27.5	27.5	27.5	27	16.5
	kW	20	20	20	19.5	12	18.5	18.5	18.5	18	11	21	21	21	21	13	22	22	22	21.5	13
TAL 042 B	kVA	27	27	27	26	16	24.5	24.5	24.5	23.5	14.5	28.5	28.5	28.5	27.5	17	30	30	30	28.5	17.5
	kW	21.5	21.5	21.5	21	13	19.5	19.5	19.5	19	11.5	23	23	23	22	13.5	24	24	24	23	14
TAL 042 C	kVA	31	32	32	30	19	28	29	29	27.5	17.5	33	34	34	32	20	34	35	35	33	21
	kW	25	25.5	25.5	24	15	22.5	23	23	22	14	26.5	27	27	25.5	16	27	28	28	26.5	17
TAL 042 D	kVA	35	35	35	30.5	22	32	32	32	28	20	37	37	37	32.5	23.5	38.5	38.5	38.5	33.5	24
	kW	28	28	28	24.5	17.5	25.5	25.5	25.5	22.5	16	29.5	29.5	29.5	26	19	31	31	31	27	19
TAL 042 E	kVA	39.5	40	40	35	25	36	36.5	36.5	32	23	42	42.5	42.5	37	26.5	43.5	45	45	38.5	27.5
	kW	31.5	32	32	28	20	29	29	29	25.5	18.5	33.5	34	34	29.5	21	35	36	36	31	22
TAL 042 F	kVA	43	45	45	39	27	39	41	41	35.5	24.5	45.5	47.5	47.5	41.5	28.5	47.5	50	50	43	29.5
	kW	34.5	36	36	31	21.5	31	31	33	28.5	19.5	36.5	38	38	33	23	38	40	40	34.5	23.5
TAL 042 G	kVA	47.5	50	50	43	30	43	45.5	45.5	39	27.5	50	53	53	45.5	32	52	55	55	47.5	33
	kW	38	40	40	34.5	24	34.5	36.5	36.5	31	22	40	42	42	36.5	25.5	42	44	44	38	26.5
TAL 042 H	kVA	58	60	60	52	36	53	55	55	47	33	61	64	64	55	38	64	66	66	57	39.5
	kW	46	48	48	42	29	42	44	44	37.5	26.5	49	51	51	44	30.5	51	53	53	46	31.5

(*) 12-wire option

Ratings 60 Hz - 1800 R.P.M.

kVA / kW - P.F. = 0.8																					
Duty / T° C		Continuous / 40 °C					Continuous / 40 °C					Stand-by / 40 °C				Stand-by / 27 °C					
Class / T° K		H / 125° K					F / 105° K					H / 150° K				H / 163° K					
Phase		3 ph.			1 ph.		3 ph.			1 ph.		3 ph.		1 ph.		3 ph.			1 ph.		
Y		380V	416V	440V	480V		380V	416V	440V	480V		380V	416V	440V	480V		380V	416V	440V	480V	
Δ		220V	240V		240V		220V	240V		240V		220V	240V		240V		220V	240V		240V	
YY (*)		208V				240V	208V				240V	208V				240V	208V				240V
ΔΔ (*)						240V					240V					240V					240V
TAL 042 A	kVA	29	31.5	31.5	31.5	18.9	26.5	28.5	28.5	28.5	17	30.5	33.5	33.5	33.5	20	32	34.5	34.5	34.5	20.8
	kW	23	25	25	25	15	21	23	23	23	13.5	24.5	27	27	27	16	25.5	27.5	27.5	27.5	16.5
TAL 042 B	kVA	30	32	34	34	19.2	27.5	29	31	31	17.5	32	34	36	36	20.5	33	35	37.5	37.5	21.1
	kW	24	25.5	27	27	15.5	22	23	25	25	14	25.5	27	29	29	16.5	26.5	28	30	30	17
TAL 042 C	kVA	33.5	37	39	40	23	30.5	33.5	35.5	36.5	21	35.5	39	41.5	42.5	24.5	37	40.5	43	44	25.5
	kW	27	29.5	31	32	18.5	24.5	27	28.5	29	17	28.5	31	33	34	19.5	29.5	32.5	34.5	35	20.5
TAL 042 D	kVA	37.5	40.5	43	44	24	34	37	39	40	22	40	43	45.5	46.5	25.5	41.5	44.3	47.5	48.5	26.5
	kW	30	32.5	34.5	35	19	27	29.5	31	32	17.5	32	34.5	36.5	37	20.5	33	35.5	38	39	21
TAL 042 E	kVA	41.5	45.5	48.5	50	27.5	38	41.5	44	45.5	25	44	48	51	53	29	45.5	50	53.5	55	30.5
	kW	33	36.5	39	40	22	30.5	33	35	36.5	20	35	38.5	41	42	23	36.5	40	43	44	24.5
TAL 042 F	kVA	44	48	51	56.5	30	40	43.5	46.5	51	27.5	46.5	51	54	60	32	48.5	53	56	62	33
	kW	35	38.5	41	45	24	32	35	37	41	22	37	41	43	48	25.5	39	42	45	50	26.5
TAL 042 G	kVA	49	53.5	56.5	62.5	34	44.5	48.5	51	57	31	52	57	60	66.5	36	54	59	62	69	37.5
	kW	39	43	45	50	27	35.5	39	41	46	25	42	46	48	53	29	43	47	50	55	30
TAL 042 H	kVA	57	63	66.5	75	39	52	57	61	68	35.5	60	67	70	80	41.5	62.5	69	73	82.5	43
	kW	46	50	53	60	31	42	46	49	54	28.5	48	54	56	64	33	50	55	58	66	34.5

(*) 12-wire option

Efficiencies 400 V - 50 Hz (— P.F.: 0.8) (----- P.F.: 1)

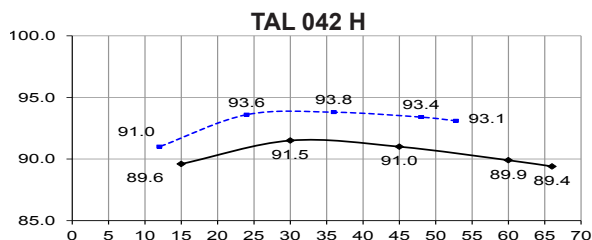
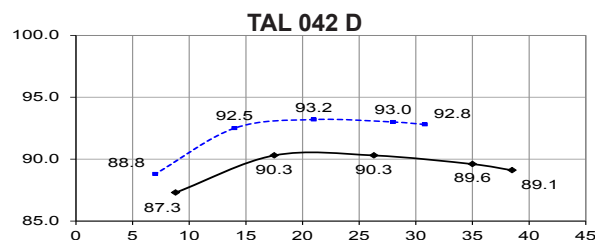
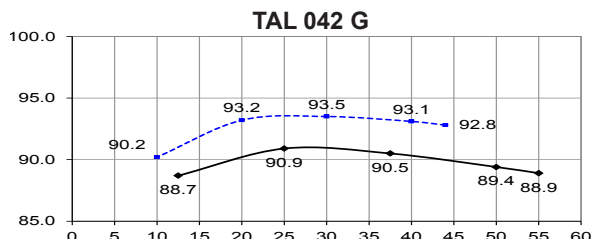
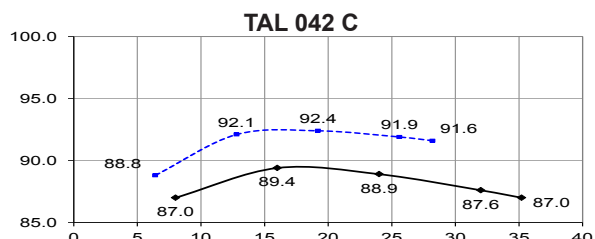
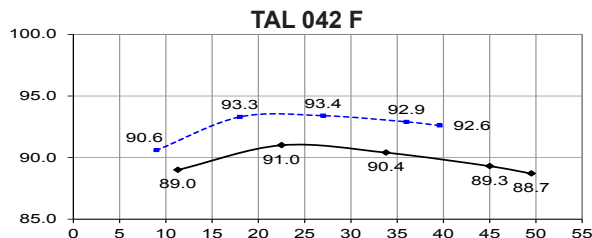
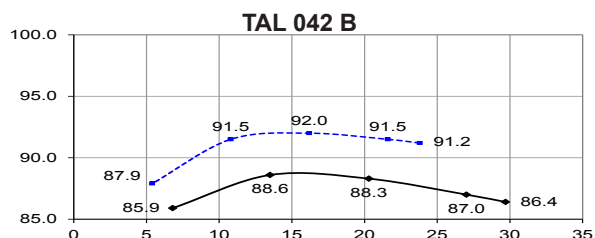
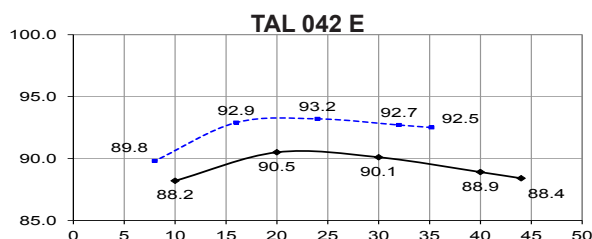
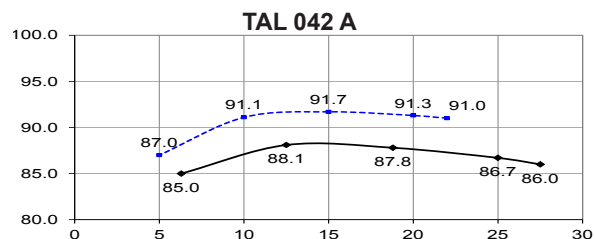

Reactances (%). Time constants (ms) - Class H / 400 V

	A	B	C	D	E	F	G	H
Kcc Short-circuit ratio	0.49	0.46	0.44	0.49	0.42	0.4	0.43	0.4
Xd Direct-axis synchro. reactance unsaturated	257	267	279	246	281	294	283	303
Xq Quadrature-axis synchro. reactance unsaturated	131	136	142	125	143	150	144	154
T'do No-load transient time constant	786	813	861	944	944	980	998	1031
X'd Direct-axis transient reactance saturated	16.3	16.4	16.2	13	14.8	15	14.1	14.7
T'd Short-circuit transient time constant	50	50	50	50	50	50	50	50
X''d Direct-axis subtransient reactance saturated	8.1	8.2	8.1	6.5	7.4	7.5	7	7.3
T''d Subtransient time constant	5	5	5	5	5	5	5	5
X''q Quadrature-axis subtransient reactance saturated	11.5	11.6	11.5	9.2	10.6	10.7	10.1	10.5
Xo Zero sequence reactance	0.68	0.68	0.67	0.54	0.62	0.62	0.59	0.61
X2 Negative sequence reactance saturated	9.88	9.91	9.82	7.89	9.02	9.12	8.61	8.93
Ta Armature time constant	8	8	8	8	8	8	8	8

Other class H / 400 V data

io (A) No-load excitation current SHUNT and AREP (*)	0.63	0.6	0.59	0.56	0.56	0.54	0.58	0.50 / 0.74
ic (A) On-load excitation current SHUNT and AREP (*)	2.14	2.13	2.21	1.92	2.19	2.23	2.38	2.11 / 3.24
uc (V) On-load excitation voltage SHUNT and AREP (*)	32.2	32	32.8	28.5	32.1	32.3	33.9	33.5 / 21.4
ms Response time ($\Delta U = 20\%$ transient)	500	500	500	500	500	500	500	500
kVA (**) Start ($\Delta U = 20\%$ cont. or $\Delta U = 30\%$ trans.) SHUNT	37.4	40.3	48.2	65.6	65.9	73.4	86.4	99.5
kVA (**) Start ($\Delta U = 20\%$ cont. or $\Delta U = 30\%$ trans.) AREP	44.7	48.1	58	78.8	78.9	88	103.6	119.2
% Transient ΔU (on-load 4/4) SHUNT - P.F.: 0.8 _{LAG}	20.1	20.1	20	17.5	19	19.1	18.4	18.9
% Transient ΔU (on-load 4/4) AREP - P.F.: 0.8 _{LAG}	18	18	17.9	15.7	17	17.1	16.5	16.9
W No-load losses	739	733	785	888	888	908	1063	1152
W Heat dissipation	3067	3209	3593	3248	3955	4307	4694	5364

(*) SHUNT / AREP : H - (**) P.F. = 0.6

Transient voltage variation 400V - 50 Hz

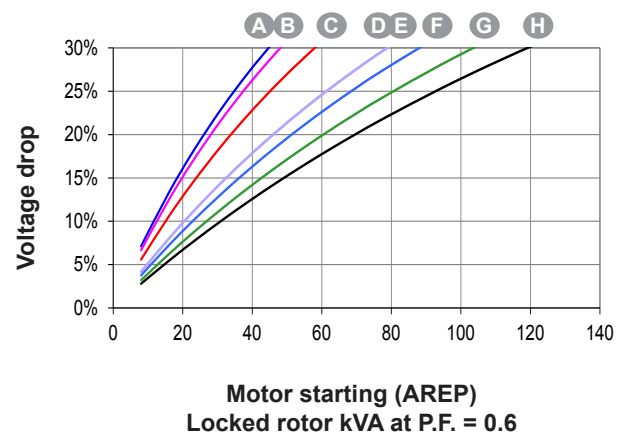
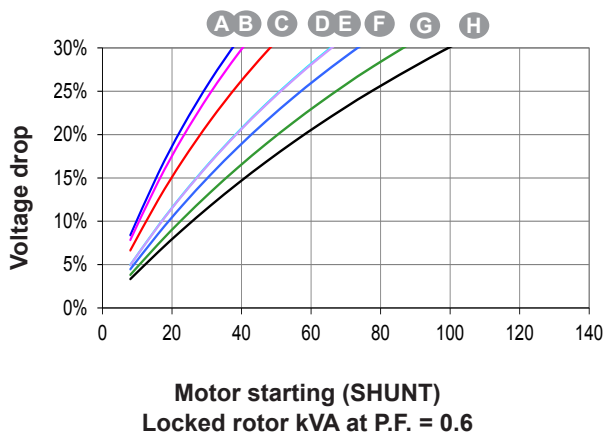
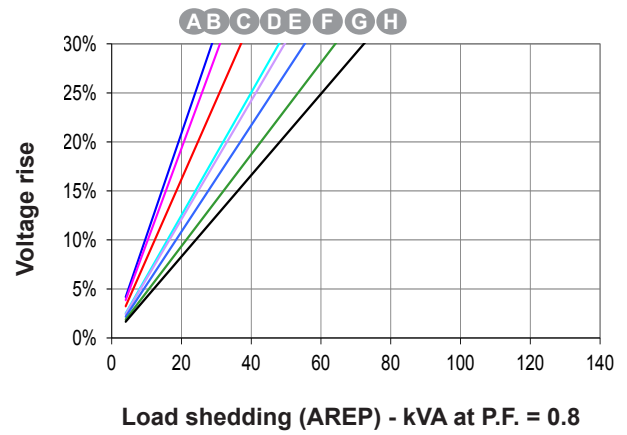
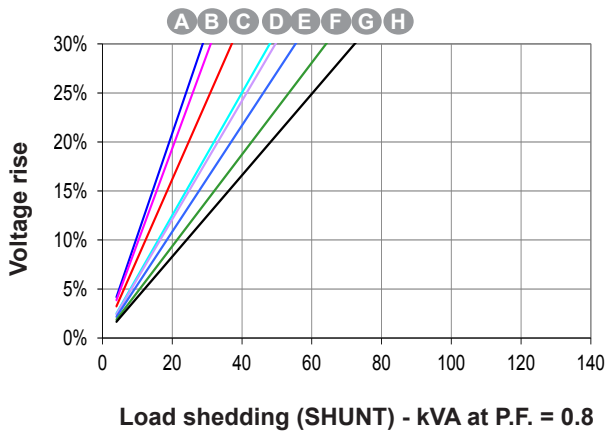
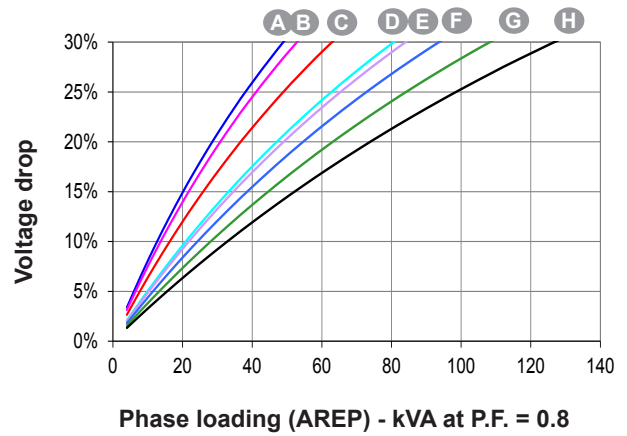
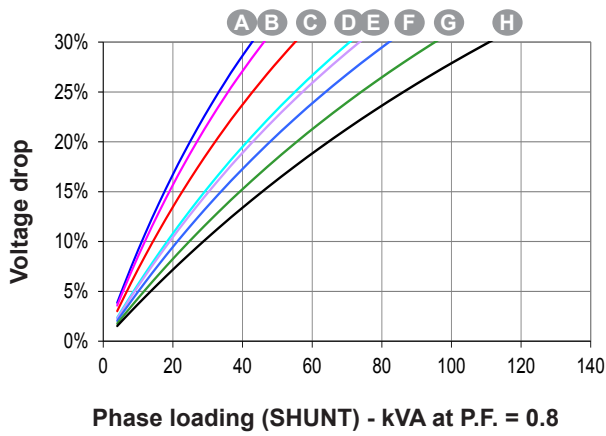

- 1) For a starting P.F. other than 0.6, the starting kVA must be multiplied by $K = \text{Sine P.F.} / 0.8$
- 2) For voltages other than 400V (Y), 230V (Δ) at 50 Hz, then kVA must be multiplied by $(400/U)^2$ or $(230/U)^2$.

Efficiencies 480 V - 60 Hz (— P.F.: 0.8) (----- P.F.: 1)

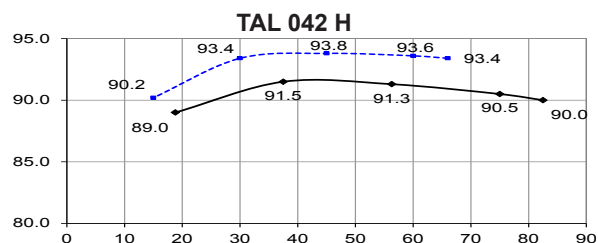
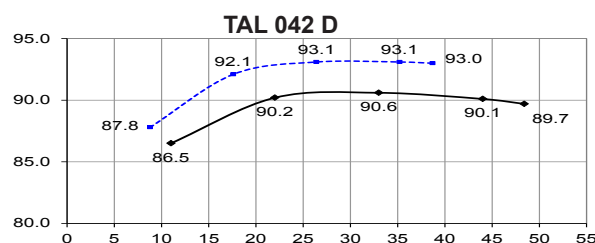
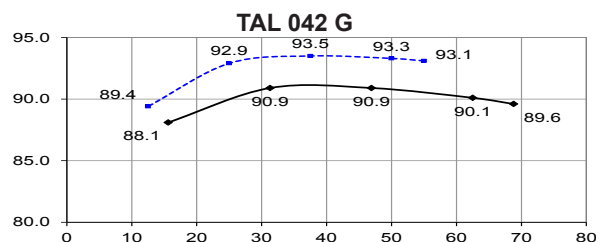
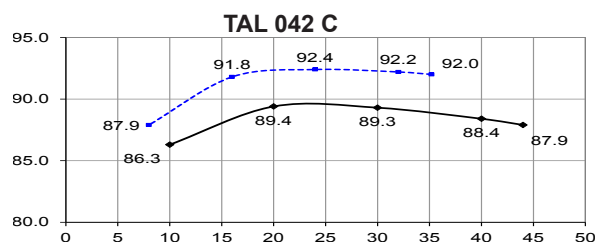
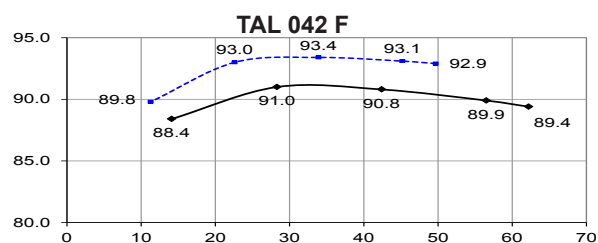
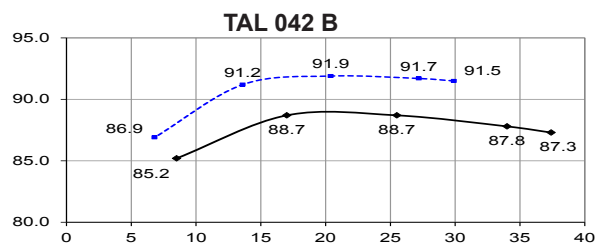
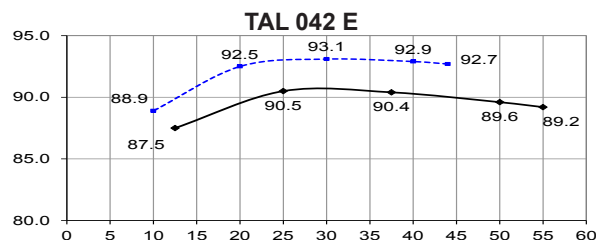
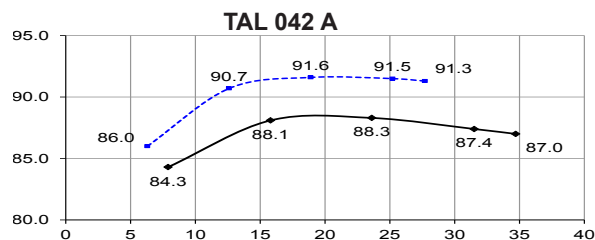

Reactances (%). Time constants (ms) - Class H / 480 V

	A	B	C	D	E	F	G	H
Kcc Short-circuit ratio	0.47	0.44	0.42	0.46	0.41	0.38	0.41	0.38
Xd Direct-axis synchro. reactance unsaturated	270	280	292	257	292	308	295	316
Xq Quadrature-axis synchro. reactance unsaturated	138	143	148	131	149	157	150	161
T'do No-load transient time constant	786	813	861	944	944	980	998	1031
X'd Direct-axis transient reactance saturated	17.2	17.2	16.9	13.6	15.5	15.7	14.7	15.3
T'd Short-circuit transient time constant	50	50	50	50	50	50	50	50
X''d Direct-axis subtransient reactance saturated	8.6	8.6	8.4	6.8	7.7	7.8	7.3	7.6
T''d Subtransient time constant	5	5	5	5	5	5	5	5
X''q Quadrature-axis subtransient reactance saturated	12.1	12.1	12	9.7	11	11.2	10.5	10.9
Xo Zero sequence reactance	0.71	0.71	0.7	0.56	0.64	0.65	0.61	0.63
X2 Negative sequence reactance saturated	10.37	10.4	10.24	8.27	9.39	9.55	8.97	9.3
Ta Armature time constant	8	8	8	8	8	8	8	8

Other class H / 480 V data

io (A) No-load excitation current SHUNT and AREP (*)	0.63	0.6	0.59	0.56	0.56	0.54	0.58	0.48 / 0.74
ic (A) On-load excitation current SHUNT and AREP (*)	2.16	2.15	2.21	1.92	2.17	2.21	2.32	2.05 / 3.14
uc (V) On-load excitation voltage SHUNT and AREP (*)	32.8	32.6	33.3	29	32.4	32.7	34.1	33.6 / 21.5
ms Response time ($\Delta U = 20\%$ transient)	500	500	500	500	500	500	500	500
kVA(**) Start ($\Delta U = 20\%$ cont. or $\Delta U = 30\%$ trans.) SHUNT	44.8	48.4	57.7	78.7	78.9	88.1	103.6	119.2
kVA(**) Start ($\Delta U = 20\%$ cont. or $\Delta U = 30\%$ trans.) AREP	53.6	57.7	69.4	94.3	94.5	105.4	124.1	142.7
% Transient ΔU (on-load 4/4) SHUNT - P.F.: 0.8 _{LAG}	20.7	20.7	20.5	18	19.4	19.6	18.9	19.3
% Transient ΔU (on-load 4/4) AREP - P.F.: 0.8 _{LAG}	18.5	18.6	18.4	16.2	17.4	17.6	16.9	17.3
W No-load losses	1051	1047	1121	1270	1270	1300	1513	1642
W Heat dissipation	3603	3764	4184	3867	4620	5061	5489	6277

(*) SHUNT / AREP : H - (**) P.F. = 0.6

Transient voltage variation 480V - 60 Hz

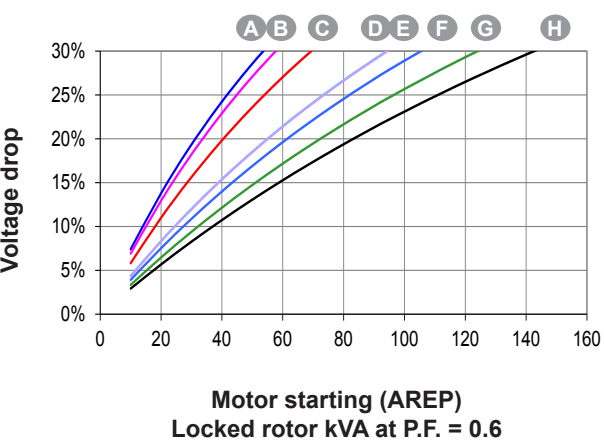
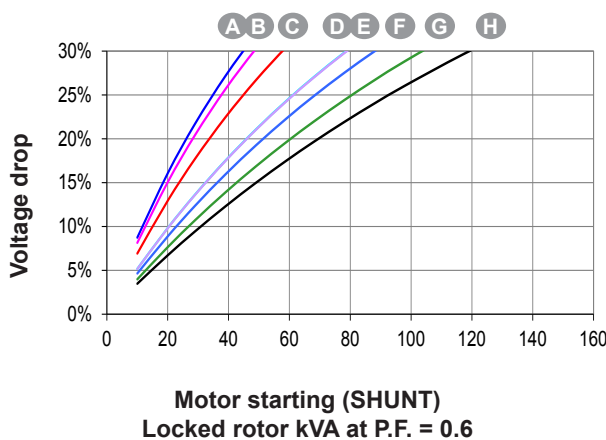
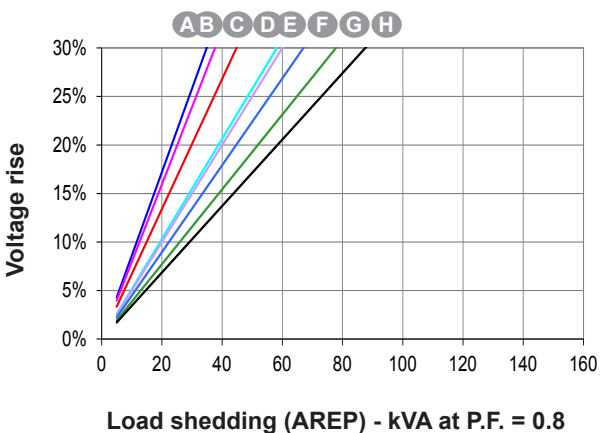
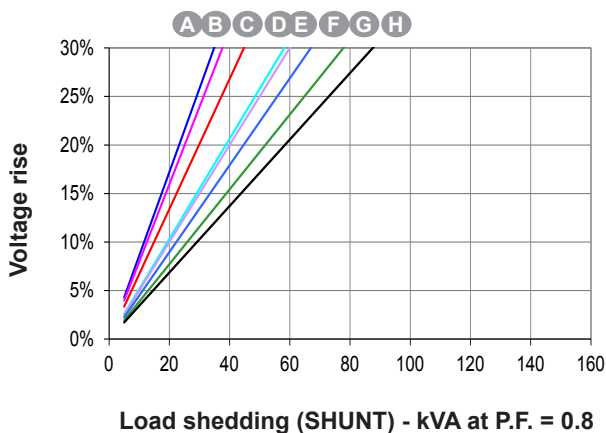
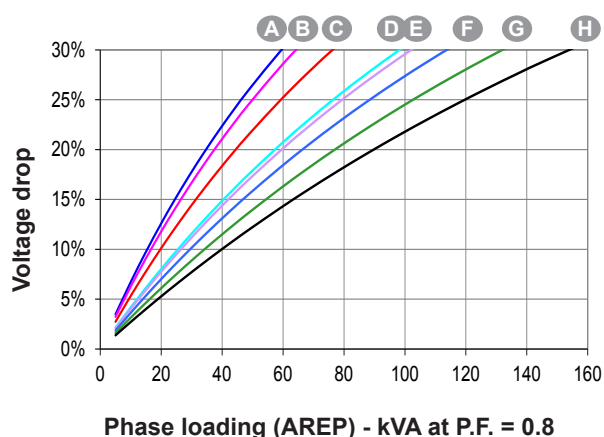
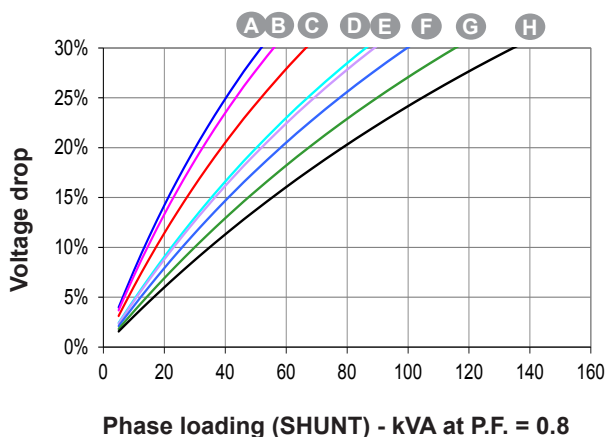

- 1) For a starting P.F. other than 0.6, the starting kVA must be multiplied by $K = \text{Sine P.F.} / 0.8$
- 2) For voltages other than 480V (Y), 277V (Δ), 240V (YY) at 60 Hz, then kVA must be multiplied by $(480/U)^2$ or $(277/U)^2$ or $(240/U)^2$.

3-phase short-circuit curves at no load and rated speed (star connection Y)

TAL 042 A

Symmetrical —
Asymmetrical - - -

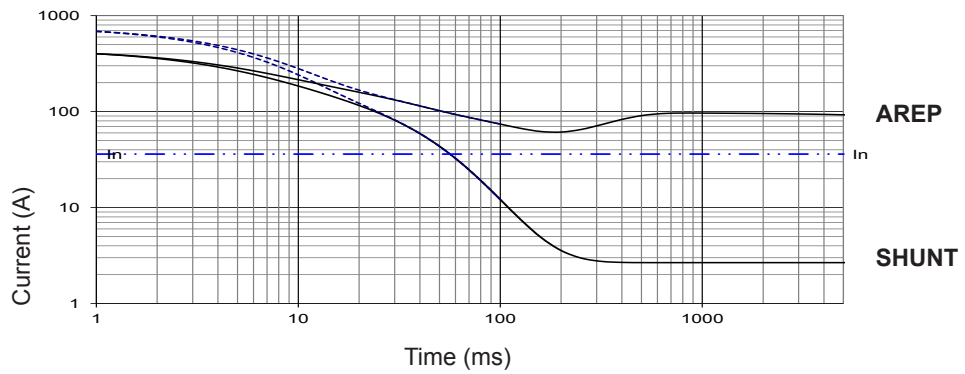

TAL 042 B

Symmetrical —
Asymmetrical - - -

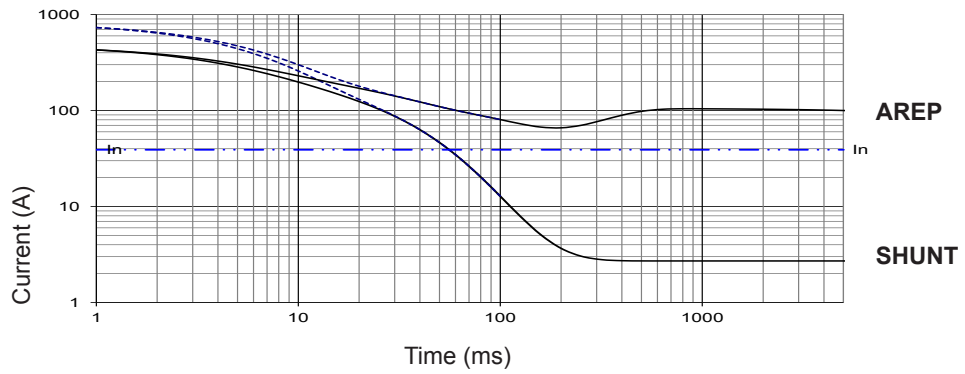

TAL 042 C

Symmetrical —
Asymmetrical - - -

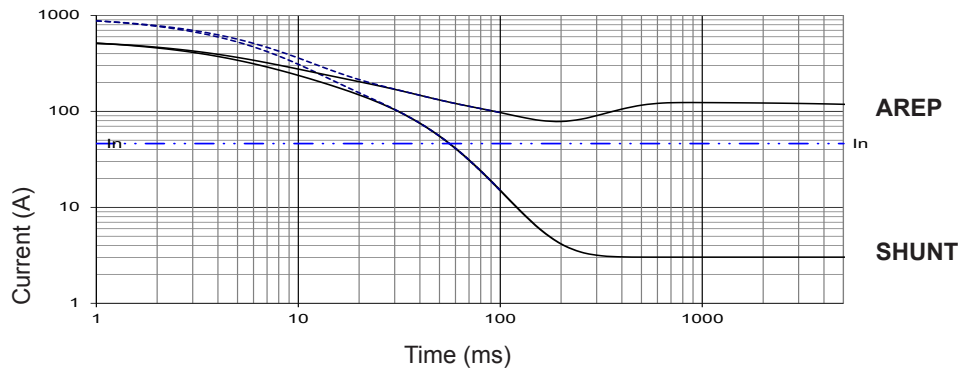

TAL 042 D

Symmetrical —
Asymmetrical - - -

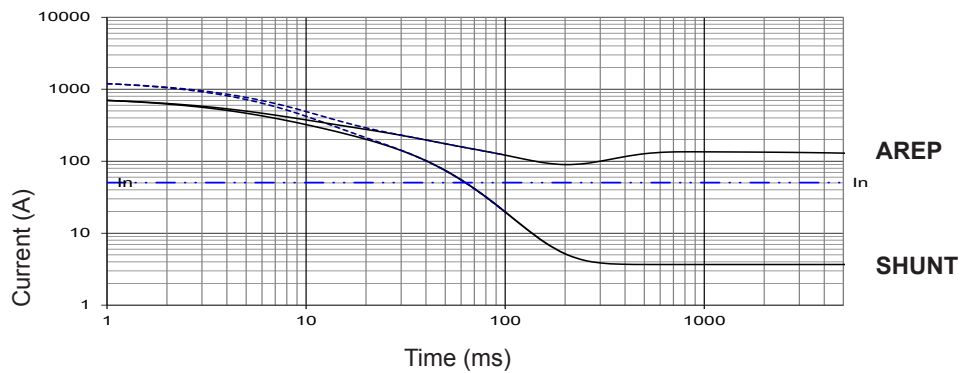

Influence due to connection

For (Δ) connection, use the following multiplication factor:
- Current value x 1.732.

3-phase short-circuit curves at no load and rated speed (star connection Y)

TAL 042 E

Symmetrical —
Asymmetrical - - -

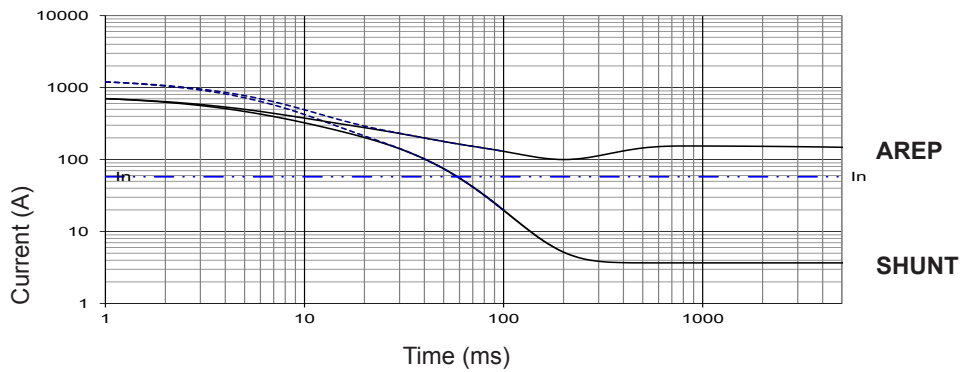

TAL 042 F

Symmetrical —
Asymmetrical - - -

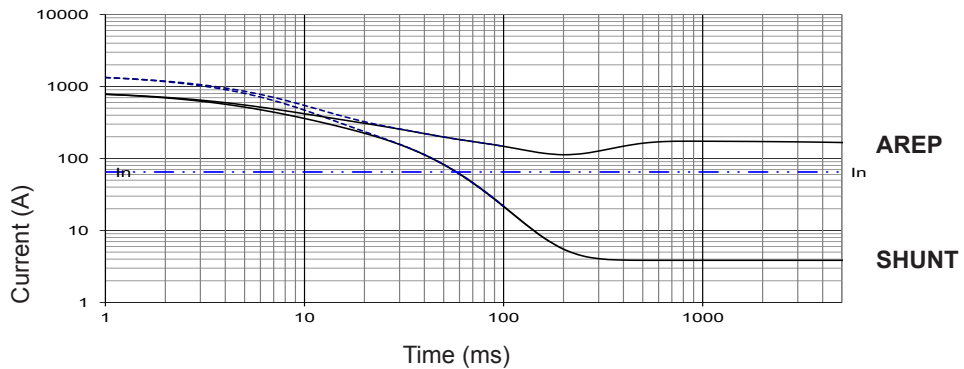

TAL 042 G

Symmetrical —
Asymmetrical - - -

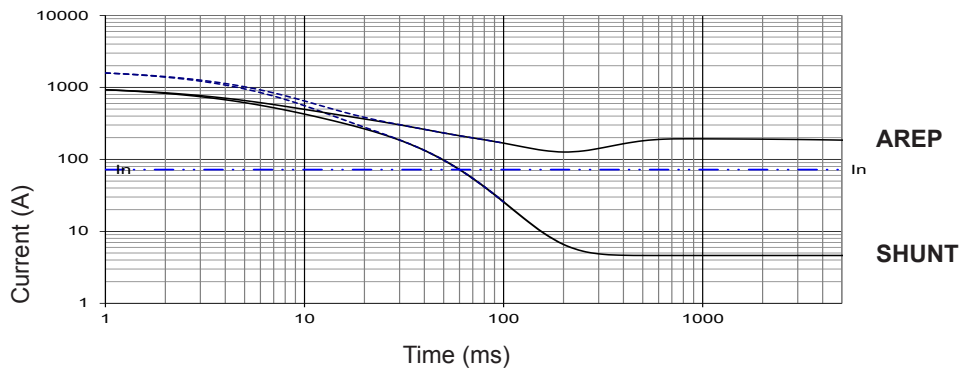

TAL 042 H

Symmetrical —
Asymmetrical - - -

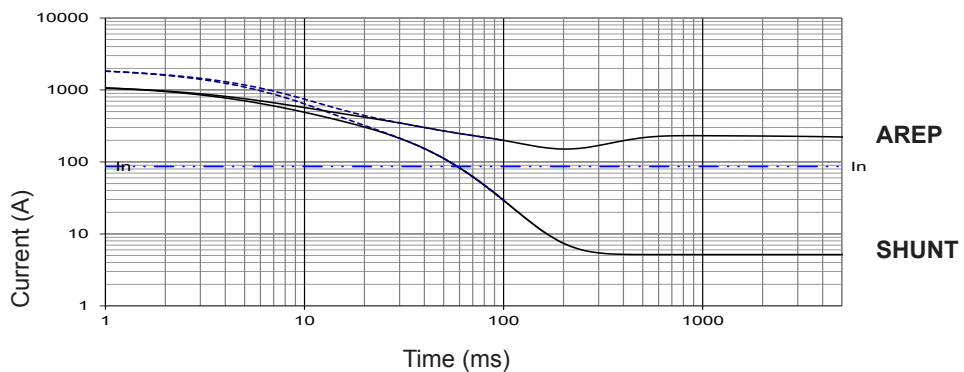

Influence due to short-circuit

Curves are based on a three-phase short-circuit.
For other types of short-circuit,
use the following multiplication factors.

	3 - phase	2 - phase L / L	1 - phase L / N
Instantaneous (max.)	1	0.87	1.3
Continuous	1	1.5	2.2
Maximum duration	1	1.5	



TAL 042 - Dedicated single-phase 18 to 42 kVA - 50 Hz / 23 to 53 kVA - 60 Hz

General characteristics



Insulation class	H	Excitation system	SHUNT
Winding pitch	2/3 (wind. M 50 Hz, M1 60 Hz)	AVR type	R121
Number of wires	4	Voltage regulation (*)	± 1 %
Protection	IP 23	Total Harmonic Distortion THD (**) in no-load	< 3.5 %
Altitude	≤ 1000 m	Total Harmonic Distortion THD (**) in linear load	< 5 %
Overspeed	2250 R.P.M.	Waveform: NEMA = TIF (**)	< 100
Air flow (m ³ /s)	50 Hz: 0.10 - 60 Hz: 0.13	Waveform: I.E.C. = FHT (**)	< 2 %

(*) Steady state (**) Total harmonic distortion between phases, no-load or on-load (non-distorting)

Ratings / Efficiencies 50 Hz - 1500 R.P.M. - Winding M

kVA / kW - P.F. = 1 (P.F. 0.8 : derating 15%)							
Duty / T° C	Continuous / 40 °C	Continuous / 40 °C	Stand-by / 40 °C	Stand-by / 27 °C			
Class / T° K	H / 125° K	F / 105° K	H / 150° K	H / 163° K			
Serie (SE) 	230 V	η %	230 V	230 V	230V	η %	
Parallel (PA) 	115 V	η %	115 V	115 V	115 V	η %	
TAL 042 A	18	88.1	16.5	19	20	87.4	
TAL 042 B	20.5	88.1	18.5	21.5	22.5	87.4	
TAL 042 C	22.5	89	20.5	24	25	88.4	
TAL 042 D	25	90.6	23	26.5	27.5	90.2	
TAL 042 E	28	90.1	25.5	29.5	31	89.6	
TAL 042 F	31.5	90.3	28.5	33.5	34.5	89.8	
TAL 042 G	35	90.4	32	37	38.5	89.9	
TAL 042 H	42	90.5	38	44.5	46	90	

Ratings / Efficiencies 60 Hz - 1800 R.P.M. - Winding M1

kVA / kW - P.F. = 1 (P.F. 0.8 : derating 15%)							
Duty / T° C	Continuous / 40 °C	Continuous / 40 °C	Stand-by / 40 °C	Stand-by / 27 °C			
Class / T° K	H / 125° K	F / 105° K	H / 150° K	H / 163° K			
Serie (SE) 	240 V	η %	240 V	240 V	240V	η %	
Parallel (PA) 	120 V	η %	120 V	120 V	120 V	η %	
TAL 042 A	23	88.3	21	24.5	25.5	87.7	
TAL 042 B	26	88.3	23.5	27.5	28.5	87.6	
TAL 042 C	29	89	26	30.5	32	88.5	
TAL 042 D	31.5	90.4	28.5	33.5	34.5	90	
TAL 042 E	36	89.8	33	38	39.5	89.2	
TAL 042 F	40	90	36.5	42.5	44	89.5	
TAL 042 G	47	90	43	50	51	89.5	
TAL 042 H	53	90.5	48	56	58	90	

Starting motor 230V - 50Hz

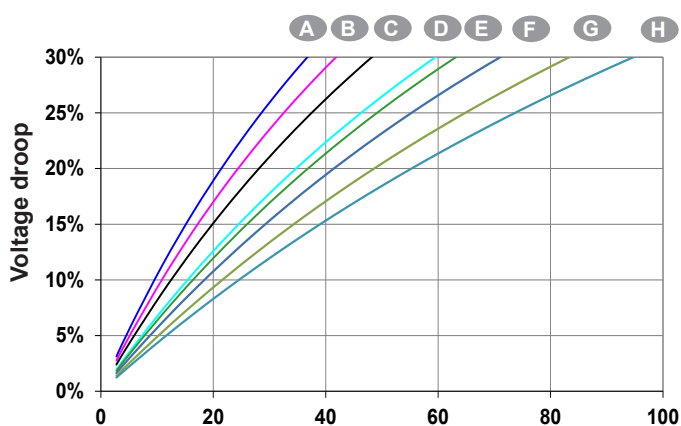

Starting motor 240V - 60Hz

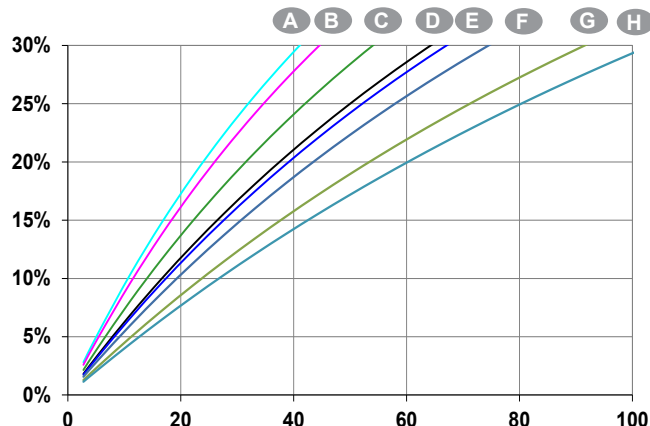

Locked rotor kVA at PF : 0.9

TAL 042 - Three-phase & Single-phase

Single bearing general arrangement

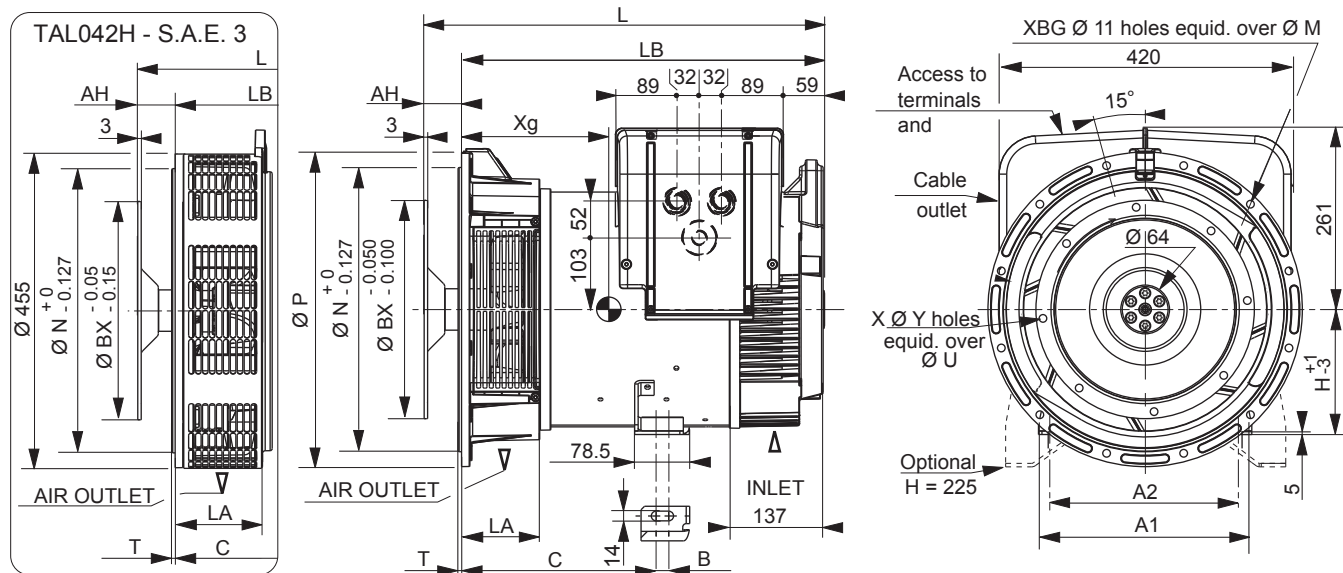

Dimensions (mm) and weight (kg)				
Type	L maxi	LB	Xg	Weight (kg)
TAL 042 A	565	503	237	117
TAL 042 B	565	503	242	122
TAL 042 C	565	503	252	133
TAL 042 D	610	548	275	165
TAL 042 E	610	548	275	165
TAL 042 F	650	588	287	181
TAL 042 G	650	588	295	186
TAL 042 H	680	618	310	187

Shaft height (mm)	
	Option
H	225
Feet length	
C	299 (A, B, C) / 312.5
B	23
A1	400
A2	356

Coupling		
Flange	3	4
Flex plate		
11 1/2	x	-
10	x	x
8	-	x
7 1/2	-	x

Flange (mm)						
S.A.E.	P	N	M	XBG	T	LA
4	406	361.95	381	12	6	122
3	452	409.58	428.62	12	5	105.3
-	-	-	-	-	-	-

Flex plate (mm)					
S.A.E.	BX	U	X	Y	AH
11 1/2	352.42	333.38	8	11	39.6
10	314.32	295.28	8	11	53.8
8	263.52	244.48	6	11	62
7 1/2	241.3	222.25	8	9	30.2

Torsional data

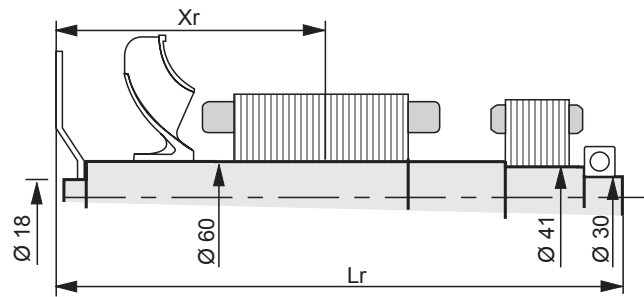

Centre of gravity: Xr (mm), Rotor length: Lr (mm), Weight: M (kg), Moment of inertia: J (kgm ²): (4J = MD ²)																
Type	Flex plate S.A.E. 7 1/2				Flex plate S.A.E. 8				Flex plate S.A.E. 10				Flex plate S.A.E. 11 1/2			
	Xr	Lr	M	J	Xr	Lr	M	J	Xr	Lr	M	J	Xr	Lr	M	J
TAL 042 A	279	526.2	44.1	0.216	277	558	44.4	0.220	274	549.8	44.9	0.211	272	535.6	45.4	0.244
TAL 042 B	282	526.2	46.1	0.229	280	558	46.4	0.233	277	549.8	46.9	0.224	274	535.6	47.4	0.257
TAL 042 C	287	526.2	50.1	0.255	286	558	50.5	0.258	283	549.8	50.9	0.249	281	535.6	51.4	0.282
TAL 042 D	310	571.2	60.2	0.312	308	603	60.6	0.316	306	594.8	61	0.307	304	580.6	61.5	0.340
TAL 042 E	310	571.2	60.2	0.312	308	603	60.6	0.316	306	594.8	61	0.307	304	580.6	61.5	0.340
TAL 042 F	325	611.2	66.2	0.344	323	643	66.5	0.348	321	634.8	66.9	0.339	319	620.6	67.4	0.372
TAL 042 G	330	611.2	69.2	0.364	328	643	69.5	0.367	326	634.8	69.9	0.358	324	620.6	70.4	0.391
TAL 042 H	344	641.2	77.5	0.414	342	673	77.8	0.418	340	664.8	78.2	0.430	338	650.6	78.8	0.442

NOTE : Dimensions are for information only and may be subject to modifications. The torsional analysis of the transmission is imperative. All values are available upon request.

© Nidec 2017. The information contained in this brochure is for guidance only and does not form part of any contract. The accuracy cannot be guaranteed as Nidec have an ongoing process of development and reserve the right to change the specification of their products without notice.

Moteurs Leroy-Somer SAS. Siège : Bd Marcellin Leroy, CS 10015, 16915 Angoulême Cedex 9, France.
Capital social : 65 800 512 €, RCS Angoulême 338 567 258.

4098 en - 2017.12 / g

LEROY-SOMER™

www.leroy-somer.com/epg

[Linkedin.com/company/Leroy-Somer](https://www.linkedin.com/company/Leroy-Somer)
[Twitter.com/Leroy_Somer_en](https://twitter.com/Leroy_Somer_en)
[Facebook.com/LeroySomer.Nidec.en](https://www.facebook.com/LeroySomer.Nidec.en)
[YouTube.com/LeroySomerOfficiel](https://www.youtube.com/LeroySomerOfficiel)

