



LSA 50.2

Low Voltage Alternators - 4 pole

1250 to 1640 kVA - 50 Hz / 1250 to 2000 kVA - 60 Hz
Electrical and mechanical data

LEROY-SOMER[™]

IMC | INTERNATIONAL
MACHINERY
& GENERATORS

Nidec
All for dreams

Specially adapted to applications

The LSA 50.2 alternator is designed to be suitable for typical generator applications, such as: backup, marine applications, rental, telecommunications, etc.

Compliant with international standards

The LSA 50.2 alternator conforms to the main international standards and regulations:

- IEC 60034, NEMA MG 1.32-33, ISO 8528-3, CSA / UL 1446 (UL 1004 on request), marine regulations, etc.

It can be integrated into a CE marked generator.

The LSA 50.2 is designed, manufactured and marketed in an ISO 9001 environment and ISO 14001.

Top of the range electrical performance

- Class H insulation
- Standard 6 wire re-connectable winding, 2/3 pitch, type no. 6S (12 wires optional / winding no. 6)
- Voltage range 50 Hz: 380V - 400V - 415V - 440 V and 220V - 230V - 240V
- Voltage range 60 Hz: 380V - 416V - 440V - 480V and 220 V - 240 V
- High efficiency and motor starting capacity
- Other voltages are possible with optional adapted windings:
 - 50 Hz : 440 V (n° 7S), 500 V (n° 9S), 600 V (n° 22S or 23S), 690 V (n° 52S)
 - 60 Hz : 380 V and 416 V (n° 8S), 600 V (n° 9S)
- R 791 interference suppression conforming to standard EN 55011 group 1 class B standard for European zone (CE marking)

Excitation and regulation system suited to the application

The LSA 50.2 can be supplied with AREP or PMG excitation system, according to the alternator specification.

Excitation system			Regulation options				
Volage regulator	AREP	PMG	Current transformer for paralleling	Mains paralleling	3-phase sensing	3-phase sensing for mains paralleling unbalanced	Remote voltage potentiometer
R450	Std	Option	C.T.	R726	-	R 734	√
D510C	Option	Option	C.T.	included	included	contact factory	√

√: Possible mounting

Protection system suited to the environment

- The LSA 50.2 is IP 23
- Standard winding protection for clean environments with relative humidity $\leq 95\%$, including indoor marine environments
 - Options : - Filters on air inlet : derating 5%
 - Filters on air inlet and air outlet (IP 44) : derating 10%
 - Winding protections for harsh environments and relative humidity greater than 95%
 - Space heaters
 - Thermal protection for winding

Reinforced mechanical structure using finite element modelling

- Compact and rigid assembly to better withstand generator vibrations
- Steel frame
- Cast iron flanges and shields
- Twin-bearing and single-bearing versions designed to be suitable for engines on the market
- Half-key balancing
- Sealed for life ball bearings, regreasable bearings (optional)
- Standard direction of rotation : clockwise when looking at the drive end view (for anti-clockwise, derate the machine by 5%)

Accessible terminal box proportioned for optional equipment

- Easy access to the voltage regulator and to the connections
- Possible inclusion of accessories for paralleling, protection and measurement
- Connection bars for winding reconnection

General characteristics

Insulation class	H	Excitation system	AREP or PMG
Winding pitch	2/3	AVR type	R 450
Number of wires	6 - (option 12)	Voltage regulation (*)	± 0.5 %
Protection	IP 23	Short-circuit current	300% (3 IN) : 10s
Altitude	≤ 1000 m	Total Harmonic Distortion THD (**) in no-load:	< 3.5 %
Overspeed	2250 min ⁻¹	Total Harmonic Distortion THD (**) on linear load:	< 3.5 %
Air flow	1.8m ³ /s, 50 Hz - 2.2m ³ /s, 60 Hz	Waveform: NEMA = TIF (**)	< 50

(*) Regulator input voltage, steady state, within the below total harmonic distortion (THD) limits.
 (**) Total harmonic distortion between phases, no-load or on-load (non-distorting).

Ratings 50 Hz - 1500 R.P.M.

kVA / kW - P.F. = 0.8																	
Duty/T°C	Continuous duty/40°C				Continuous duty/40°C				Stand-by/40°C				Stand-by/27°C				
Class/T°K	H/125°K				F/105°K				H/150°K				H/163°K				
Phase	3 ph.				3 ph.				3 ph.				3 ph.				
Y	380V	400V	415V	440V	380V	400V	415V	440V	380V	400V	415V	440V	380V	400V	415V	440V	
Δ	220V	230V	240V		220V	230V	240V		220V	230V	240V		220V	230V	240V		
6 wires version winding no. 6S																	
LSA 50.2 M6	kVA	1250	1250	1250	1190	1125	1125	1125	1095	1315	1315	1315	1275	1375	1375	1375	1330
	kW	1000	1000	1000	952	900	900	900	876	1052	1052	1052	1020	1100	1100	1100	1064
LSA 50.2 L7	kVA	1350	1350	1350	1260	1215	1215	1215	1150	1420	1420	1420	1365	1485	1485	1485	1425
	kW	1080	1080	1080	1008	972	972	972	920	1136	1136	1136	1092	1188	1188	1188	1140
LSA 50.2 L8	kVA	1450	1500	1500	1440	1320	1350	1350	1320	1520	1575	1575	1555	1595	1650	1650	1625
	kW	1160	1200	1200	1152	1056	1080	1080	1056	1216	1260	1260	1244	1276	1320	1320	1300
LSA 50.2 VL10	kVA	1600	1640	1600	1545	1455	1475	1455	1420	1680	1720	1680	1670	1760	1800	1760	1730
	kW	1280	1312	1280	1236	1164	1180	1164	1136	1344	1376	1344	1336	1408	1440	1408	1384
12 wires version winding no. 6 (option)																	
Y		380V	400V	415V	440V	380V	400V	415V	440V	380V	400V	415V	440V	380V	400V	415V	440V
Δ		220V	230V	240V		220V	230V	240V		220V	230V	240V		220V	230V	240V	
YY				220V				220V				220V				220V	
LSA 50.2 M6	kVA	1045	1100	1140	1210	940	990	1026	1287	1045	1100	1140	1210	1045	1100	1140	1210
	kW	836	880	912	968	752	792	821	1030	836	880	912	968	836	880	912	968
LSA 50.2 L8	kVA	1250	1300	1350	1430	1125	1170	1215	1089	1250	1300	1350	1430	1250	1300	1350	1430
	kW	1000	1040	1080	1144	900	936	972	871	1000	1040	1080	1144	1000	1040	1080	1144

Ratings 60 Hz - 1800 R.P.M.

kVA / kW - P.F. = 0.8																	
Duty/T°C	Continuous duty/40°C				Continuous duty/40°C				Stand-by/40°C				Stand-by/27°C				
Class/T°K	H/125°K				F/105°K				H/150°K				H/163°K				
Phase	3 ph.				3 ph.				3 ph.				3 ph.				
Y	380V	416V	440V	480V	380V	416V	440V	480V	380V	416V	440V	480V	380V	416V	440V	480V	
Δ	220V	240V			220V	240V			220V	240V			220V	240V			
6 wires version winding n°6S																	
LSA 50.2 M6	kVA	1285	1405	1455	1560	1155	1265	1310	1405	1350	1475	1530	1640	1410	1545	1600	1720
	kW	1028	1124	1164	1250	924	1012	1048	1124	1080	1180	1224	1312	1128	1236	1280	1376
LSA 50.2 L7	kVA	1375	1500	1555	1680	1240	1350	1400	1510	1440	1575	1630	1765	1510	1650	1710	1850
	kW	1100	1200	1244	1344	992	1080	1120	1208	1152	1260	1304	1412	1208	1320	1368	1480
LSA 50.2 L8	kVA	1485	1625	1720	1875	1335	1460	1550	1685	1560	1705	1805	1965	1630	1785	1890	2060
	kW	1188	1300	1376	1500	1068	1168	1240	1350	1250	1364	1444	1572	1304	1428	1512	1650
LSA 50.2 VL10	kVA	1635	1785	1860	2000	1470	1605	1675	1800	1715	1875	1950	2100	1800	1965	2050	2200
	kW	1308	1428	1488	1600	1176	1284	1340	1440	1372	1500	1560	1680	1440	1572	1640	1760
12 wires version winding n°6 (option)																	
Y		380V	416V	440V	480V	380V	416V	440V	480V	380V	416V	440V	480V	380V	416V	440V	480V
Δ		220V	240V	240V		220V	240V	240V		220V	240V	240V		220V	240V	240V	
YY		208V	220V	240V		208V	220V	240V		208V	220V	240V		208V	220V	240V	
LSA 50.2 S4	kVA	990	1080	1145	1250	891	972	1030	1125	990	1080	1145	1250	990	1080	1145	1250
	kW	792	864	916	1000	713	778	824	900	792	864	916	1000	792	864	916	1000
LSA 50.2 M6	kVA	1210	1320	1400	1525	1089	1188	1260	1372	1210	1320	1400	1525	1210	1320	1400	1525
	kW	968	1056	1120	1220	871	950	1008	1098	968	1056	1120	1220	968	1056	1120	1220
LSA 50.2 L8	kVA	1430	1565	1655	1800	1287	1409	1490	1620	1430	1565	1655	1800	1430	1565	1655	1800
	kW	1144	1252	1324	1440	1029	1127	1192	1296	1144	1252	1324	1440	1144	1252	1324	1440

Efficiencies 50 Hz

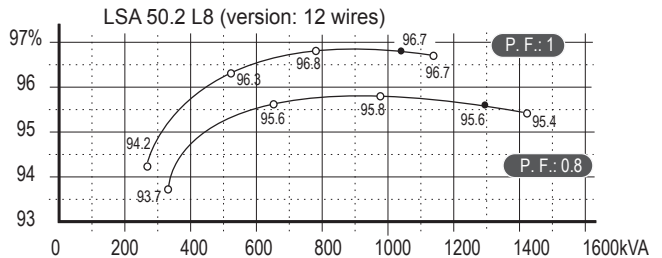
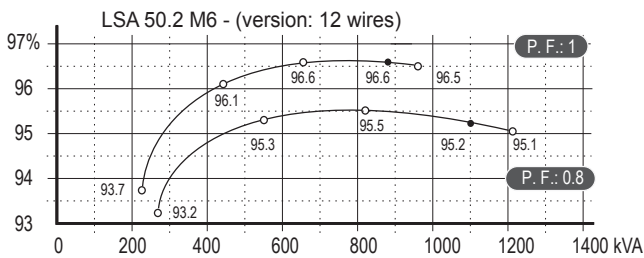
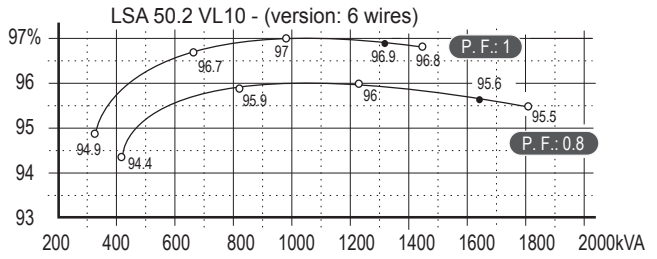
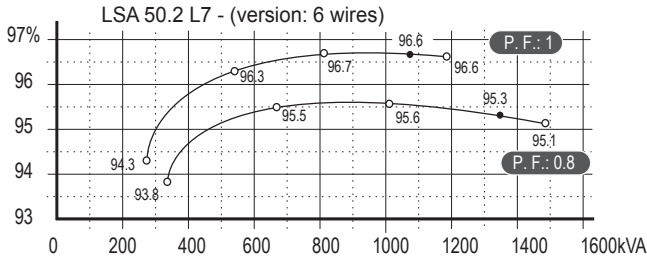
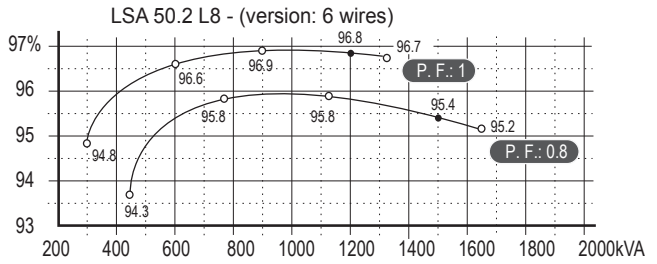
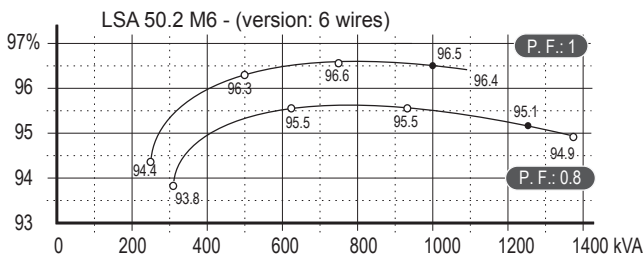

Reactances (%). Time constants (ms) - Class H / 400 V

	M6 (6f)	L7 (6f)	L8 (6f)	VL10 (6f)	M6 (12f)	L8 (12f)
Kcc Short-circuit ratio	0.31	0.34	0.31	0.33	0.36	0.37
Xd Direct-axis synchro. reactance unsaturated	392	364	378	362	345	329
Xq Quadrature-axis synchro. reactance unsaturated	235	218	227	217	207	197
T'do No-load transient time constant	3634	3750	3910	4058	3634	4247
X'd Direct-axis transient reactance saturated	19.4	17.4	17.4	16.0	17.0	13.9
T'd Short-circuit transient time constant	180	180	180	180	180	180
X''d Direct-axis subtransient reactance saturated	16.5	14.8	14.8	13.6	14.5	11.8
T''d Subtransient time constant	18	18	18	18	18	18
X''q Quadrature-axis subtransient reactance saturated	17.3	15.5	15.4	14.2	15.2	13.4
Xo Zero sequence reactance unsaturated	3.6	3.6	3.3	3.1	3.60	3.30
X2 Negative sequence reactance saturated	16.9	15.2	15.1	13.9	14.89	12.67
Ta Armature time constant	27	27	27	27	27.0	27.0

Other class H/400 V data

io (A) No-load excitation current	0.9	1.0	0.9	0.9	0.82	0.80
ic (A) On-load excitation current	4.1	4.0	3.9	3.7	3.21	3.01
uc (V) On-load excitation voltage	44	44	42	41	40.3	37.9
ms Response time ($\Delta U = 20\%$ transient)	500	500	500	500	500	500
kVA Start ($\Delta U = 20\%$ cont. or 50% trans.)	2895	3181	3701	4248	2300	3325
% Transient ΔU (on-load 4/4) - P.F.: 0.8 _{LAG}	13.5	12.4	12.4	11.7	12.3	10.5
W No-load losses	13960	15260	15420	16520	14025	15310
W Heat dissipation	51240	53260	57110	59020	43515	47696

Transient voltage variation 400V - 50 Hz

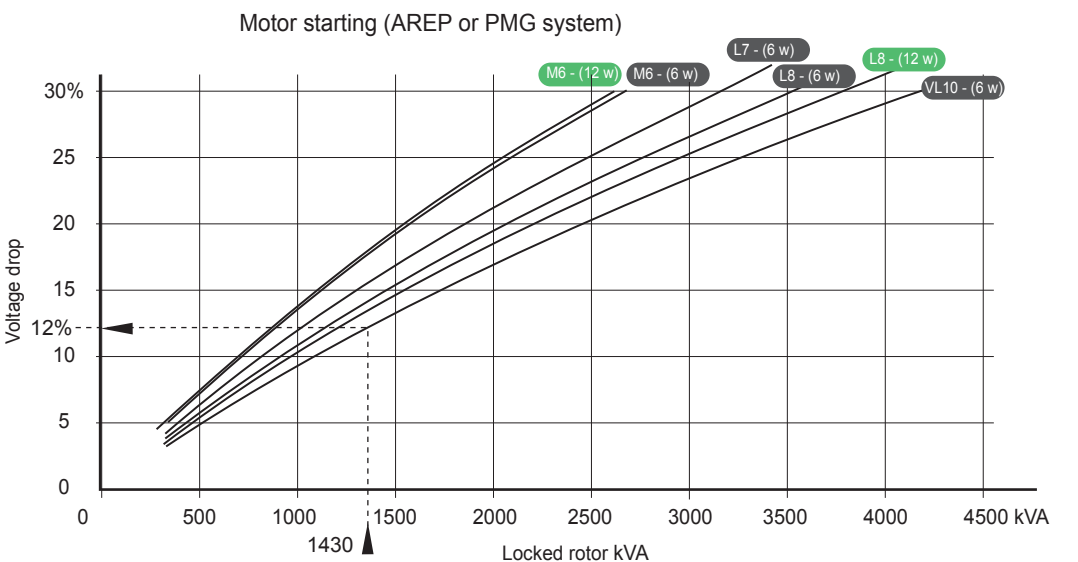
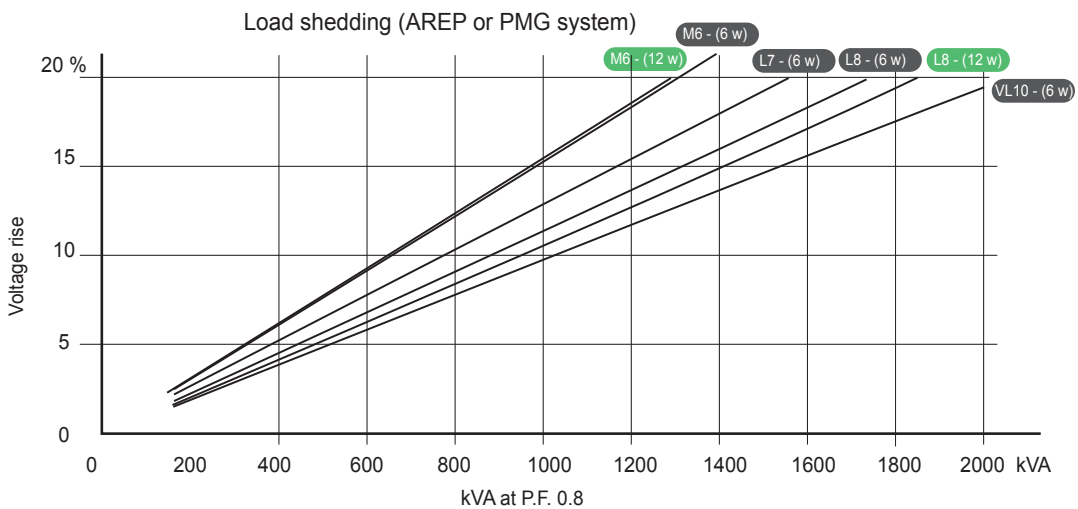
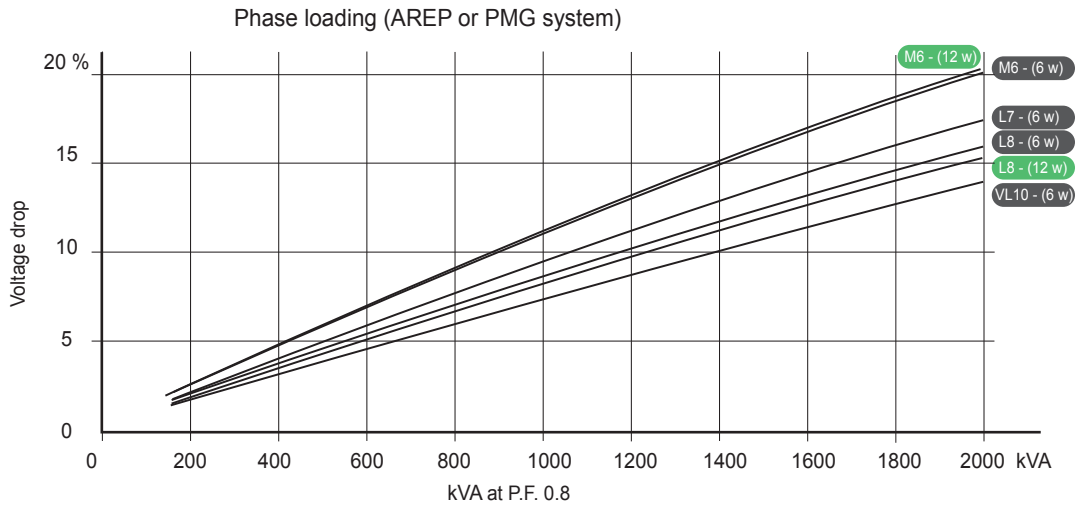

- 1) For a starting P.F. other than 0.6, the starting kVA must be multiplied by $K = \text{Sine P.F.} / 0.8$
 Calculation example for a different P.F. other than 0.6: Starter motor kVA calculated at 0.4 P.F. = 1250 kVA
 ➤ $\text{Sin P.F. } 0.4 = 0.9165$ ➤ $K = 1.145$ ➤ $\text{kVA corrected} = 1430 \text{ kVA}$ ➤ Voltage dip corresponding to VL10 = 12%.
- 2) For voltages other than 400V (Y), 230V (Δ) at 50 Hz, then kVA must be multiplied by $(400/U)^2$ or $(230/U)^2$.

Efficiencies 60 Hz

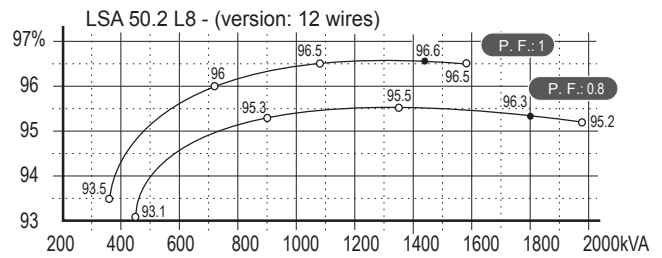
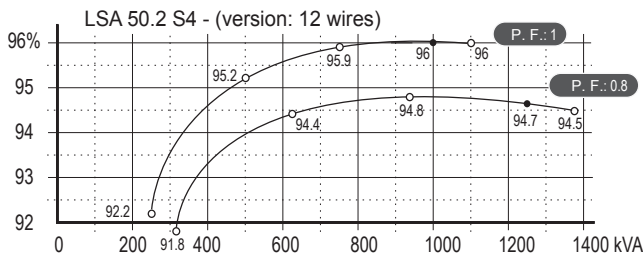
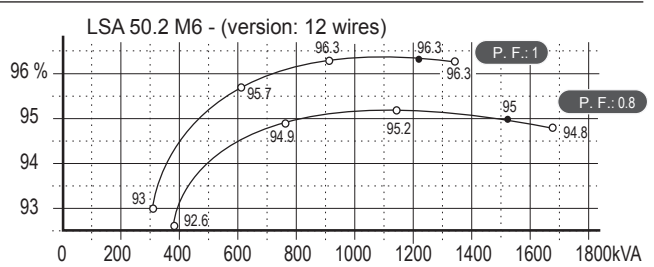
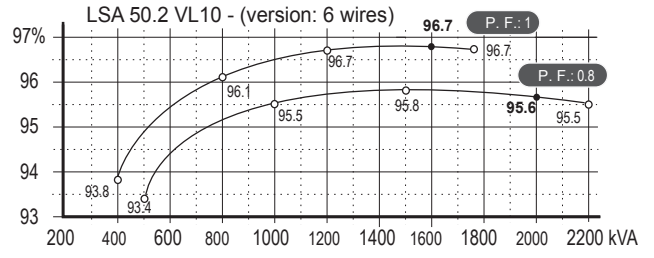
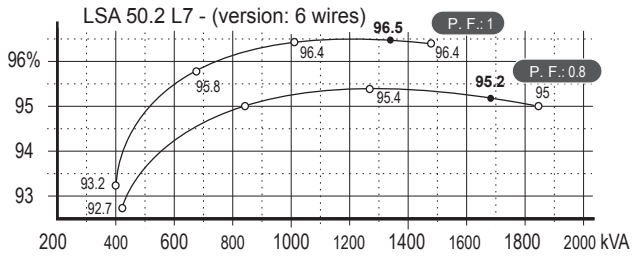
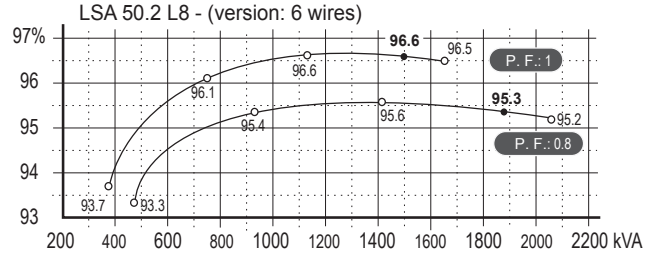
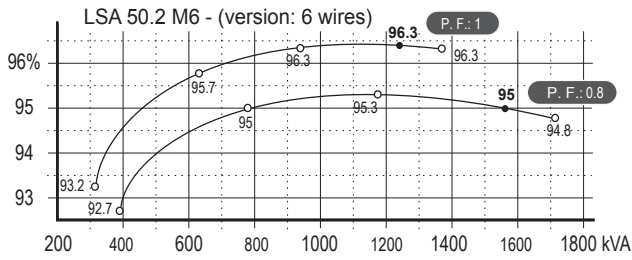

Reactances (%). Time constants (ms) - Class H / 480 V

		M6 (6f)	L7 (6f)	L8 (6f)	VL10 (6f)	S4(12f)	M6(12f)	L8(12f)
Kcc	Short-circuit ratio	0.29	0.33	0.30	0.32	0.30	0.31	0.32
Xd	Direct-axis synchro. reactance unsaturated	407	377	394	368	394	398	380
Xq	Quadrature-axis synchro. reactance unsaturated	244	226	236	220	236	239	228
T'do	No-load transient time constant	3634	3750	3910	4058	3411	3634	4247
X'd	Direct-axis transient reactance saturated	20.2	18.1	18.1	16.3	20.8	19.7	16.1
T'd	Short-circuit transient time constant	180	180	180	180	180	180	180
X''d	Direct-axis subtransient reactance saturated	17.1	15.4	15.4	13.8	17.7	16.7	13.7
T''d	Subtransient time constant	18	18	18	18	18	18	18
X''q	Quadrature-axis subtransient reactance saturated	18.0	16.1	16.1	14.4	18.6	17.6	13.4
Xo	Zero sequence reactance unsaturated	3.7	3.7	3.5	3.1	3.90	3.70	3.50
X2	Negative sequence reactance saturated	17.6	15.8	15.8	14.2	18.19	17.21	14.62
Ta	Armature time constant	27	27	27	27	27.0	27.0	27.0

Other class H/480 V data

io (A)	No-load excitation current	0.9	0.9	0.9	0.9	0.78	0.82	0.79
ic (A)	On-load excitation current	4.2	4.1	4.0	3.7	3.48	3.60	3.37
uc (V)	On-load excitation voltage	46	45	44	41	43.9	45.3	42.4
ms	Response time ($\Delta U = 20\%$ transient)	500	500	500	500	500	500	500
kVA	Start ($\Delta U = 20\%$ cont. or 50% trans.)	3553	3927	4593	5281	2148.5	2766.5	3993.9
%	Transient ΔU (on-load 4/4) - P.F.: 0.8 _{LAG}	13.9	12.8	12.8	11.8	14.3	13.7	11.7
W	No-load losses	22000	23820	24080	25640	20431	22067	23904
W	Heat dissipation	64830	67290	72430	72720	55785	63639	69741

Transient voltage variation 480V - 60 Hz

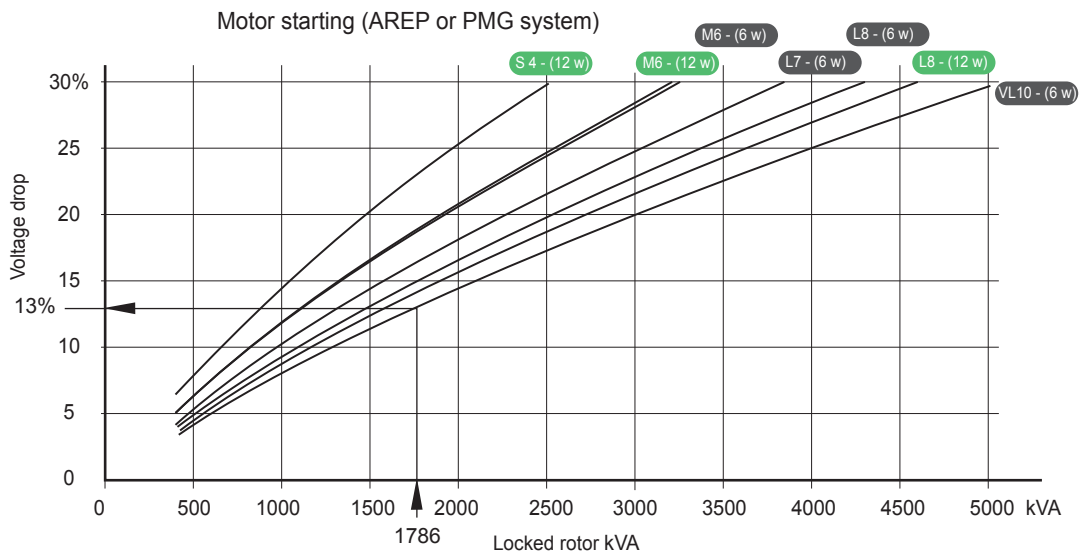
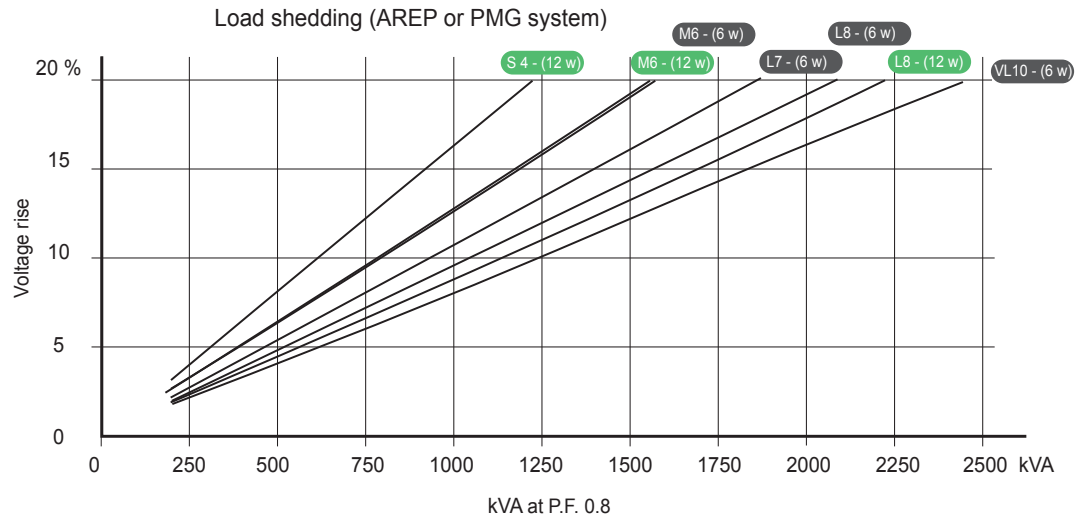
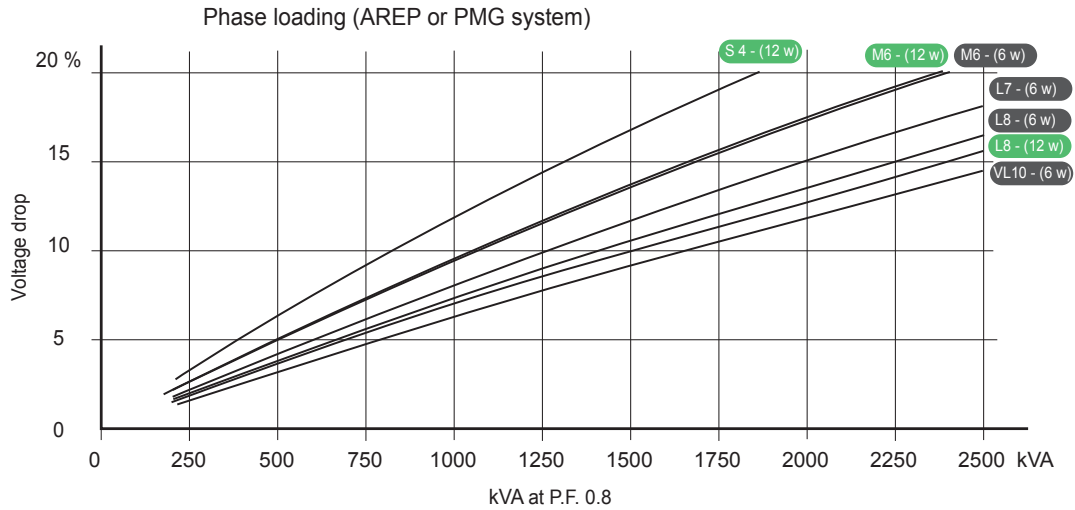

- 1) For a starting P.F. other than 0.6, the starting kVA must be multiplied by $K = \text{Sine P.F.} / 0.8$
 Calculation example for a different P.F. other than 0.6: Starter motor kVA calculated at 0.4 P.F. = 1560 kVA
 ➤ $\text{Sin P.F. } 0.4 = 0.9165$ ➤ $K = 1.145$ ➤ $\text{kVA corrected} = 1786 \text{ kVA}$ ➤ Voltage dip corresponding to VL10 = 13%.
- 2) For voltages other than 480V (Y), 277V (Δ), 240V (YY) at 60 Hz, then kVA must be multiplied by $(480/U)^2$ or $(277/U)^2$ or $(240/U)^2$.

3-phase short-circuit curves at no load and rated speed (star connection Y)

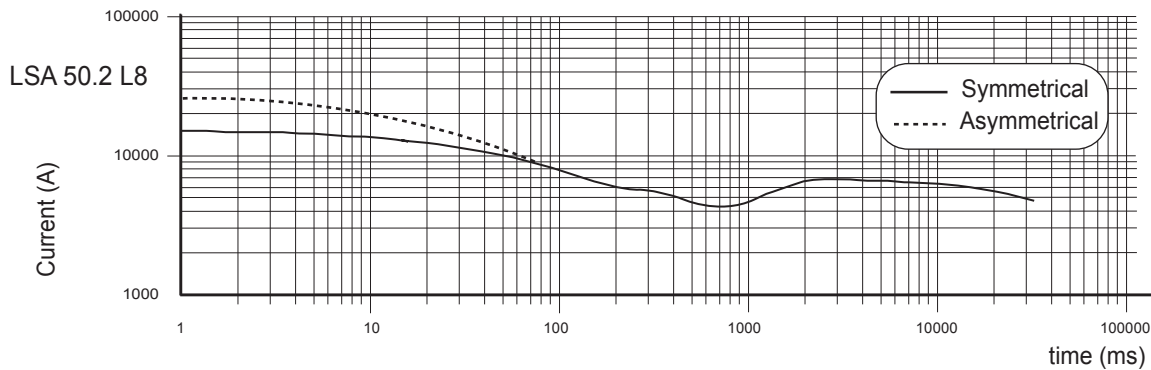
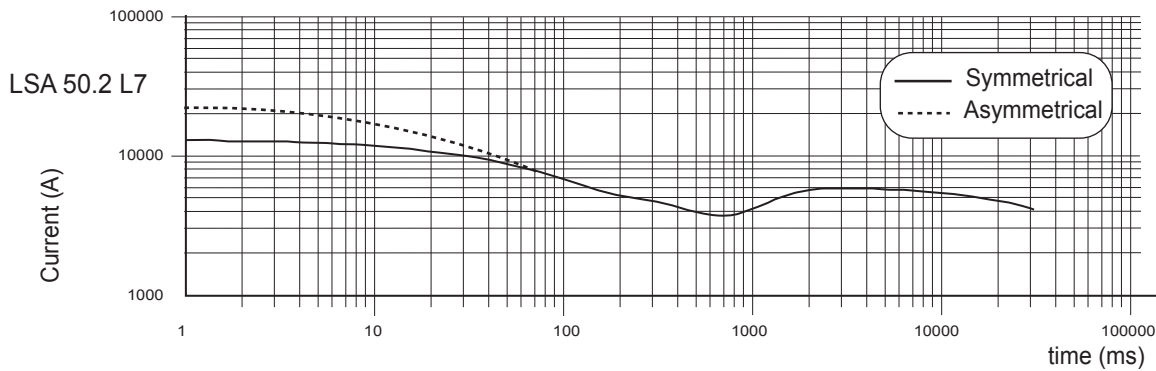
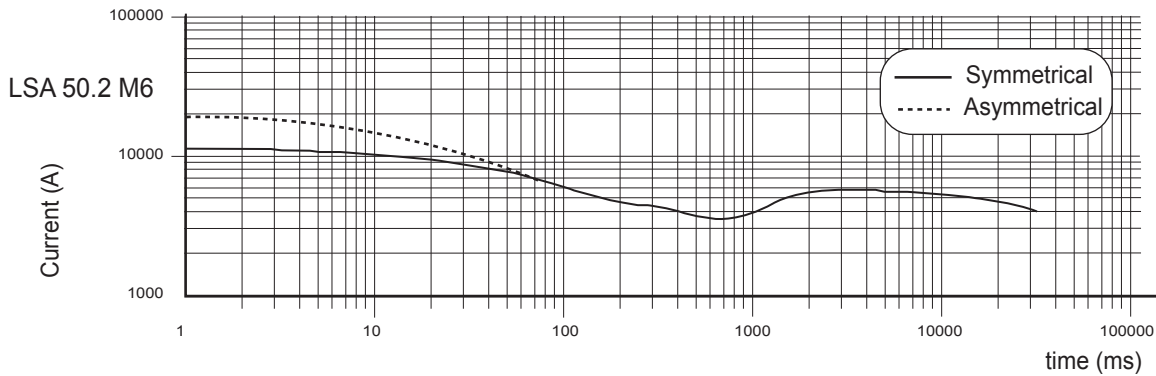
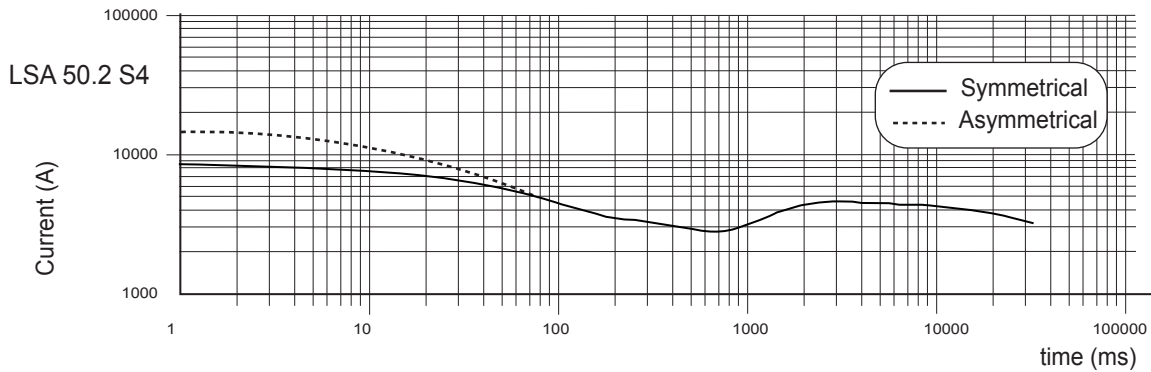

Influence due to connection

Curves shown are for star (Y) connection.

For other connections, use the following multiplication factors:

- Series delta : current value x 1.732
- Parallel star : current value x 2

3-phase short-circuit curves at no load and rated speed (star connection Y)

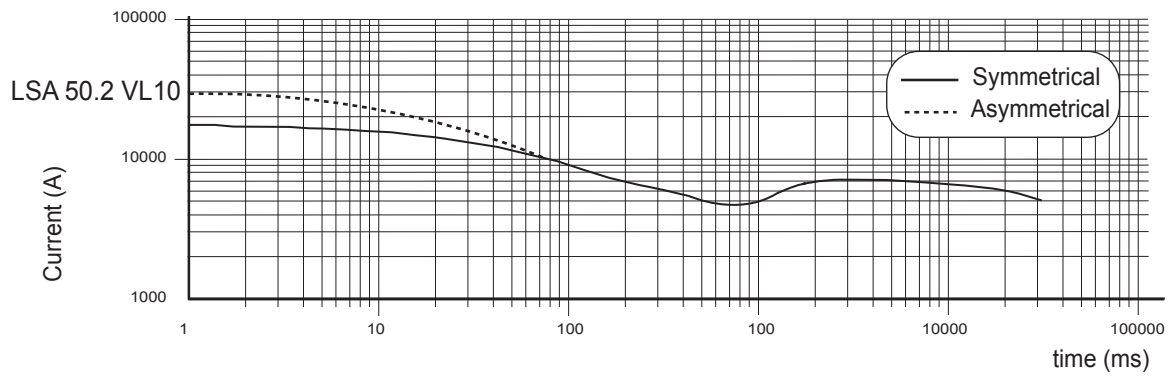

Influence due to short-circuit

Curves are based on a three-phase short-circuit.
For other types of short-circuit, use the following multiplication factors.

	3-phase	2-phase L/L	1-phase L/N
Instantaneous (max.)	1	0.87	1.3
Continuous	1	1.5	2.2
Maximum duration (AREP/PMG)	10 sec.	5 sec.	2 sec.

Single bearing dimensions

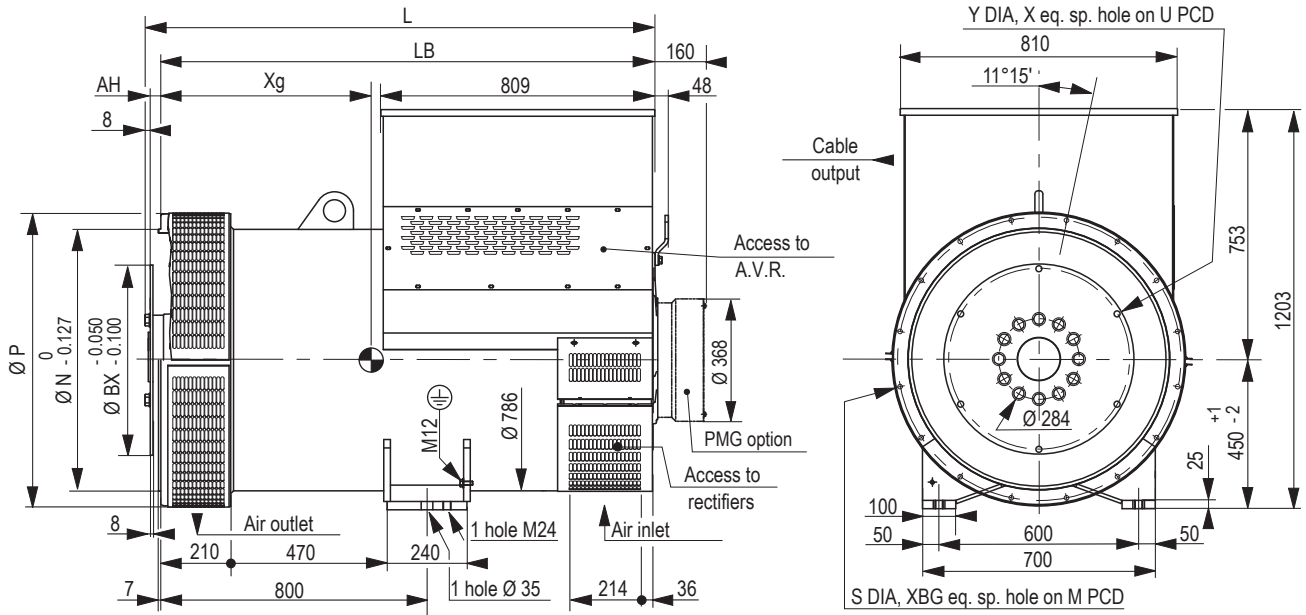

Dimensions (mm) and weight

Type	L without PMG	LB	Xg	Weight (kg)
LSA 50.2 S4	1302	1278	620	2290
LSA 50.2 M6	1402	1378	640	2490
LSA 50.2 L7	1502	1478	690	2760
LSA 50.2 L8	1502	1478	710	2980
LSA 50.2 VL10	1602	1578	760	3260

Coupling

Flex plate	18	21
Flange S.A.E 0	X	
Flange S.A.E 00	X	X

Flange (mm)

S.A.E.	P	N	M	XBG	β°
0	880	647.7	679.5	16	14
00	880	787.4	850.9	16	14

Flex plate (mm)

S.A.E.	BX	U	X	Y	AH
21	673.1	641.3	12	18	0
18	571.5	542.9	6	18	15.7

Torsional analysis data

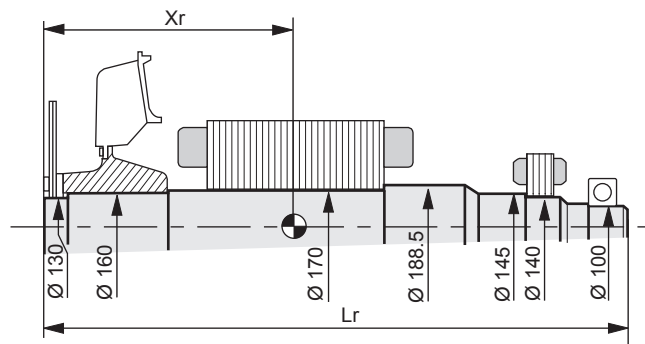

Centre of gravity: Xr (mm), Rotor length: Lr (mm), Weight: M (kg), Moment of inertia: J (kgm²): (4J = MD²)

Type	Flange S.A.E. 18				Flange S.A.E. 21			
	Xr	Lr	M	J	Xr	Lr	M	J
LSA 50.2 S4	564	1320.5	833	18.17	549	1320.5	831	18.62
LSA 50.2 M6	608	1420.5	934	20.6	593	1420.5	932	21.09
LSA 50.2 L7	643	1520.5	1005	22.23	627	1520.5	1003	22.68
LSA 50.2 L8	667	1520.5	1082	24.6	652	1520.5	1081	25.05
LSA 50.2 VL 10	714	1620.5	1192	27.27	698	1620.5	1191	27.72

NOTE : Dimensions are for information only and may be subject to modifications. Contractual 2D drawings can be downloaded from the Leroy-Somer site, 3D drawing files are available upon request. The torsional analysis of the transmission is imperative. All values are available upon request.

Two bearing dimensions

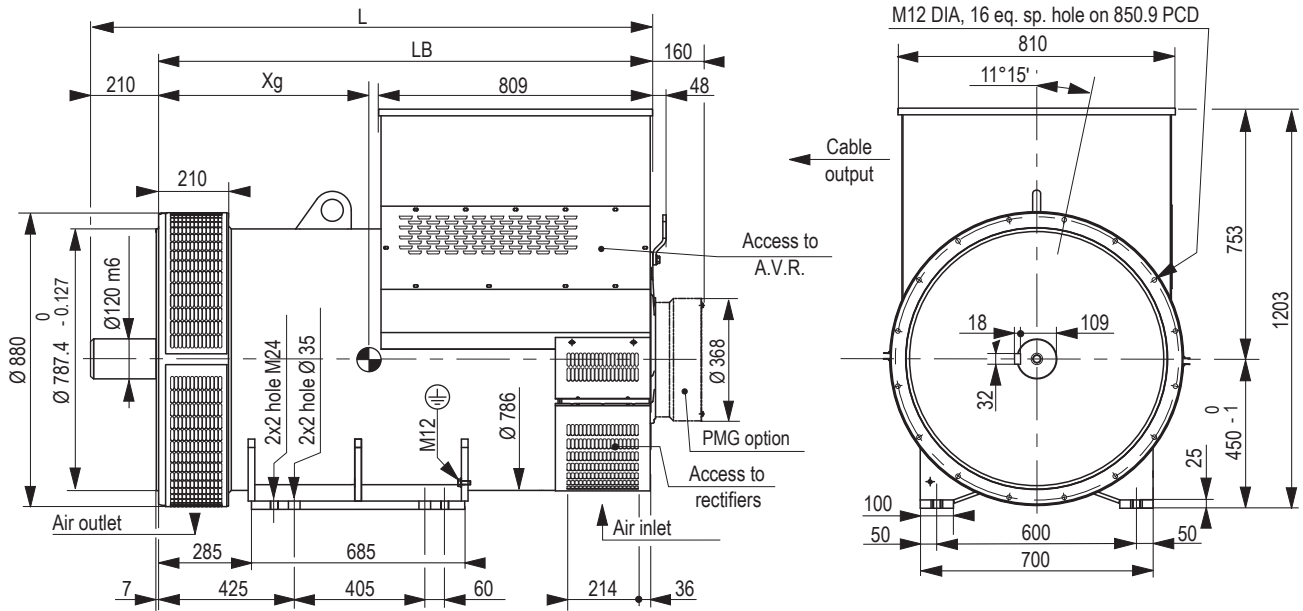

Dimensions (mm) and weight				
Type	L without PMG	LB	Xg	Weight (kg)
LSA 50.2 S4	1488	1278	600	2330
LSA 50.2 M6	1588	1378	620	2530
LSA 50.2 L7	1688	1478	670	2800
LSA 50.2 L8	1688	1478	690	3010
LSA 50.2 VL10	1788	1578	740	3300

Torsional analysis data

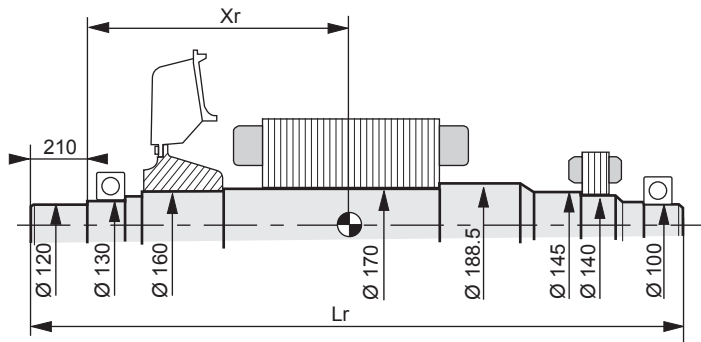

Centre of gravity: Xr (mm), Rotor length: Lr (mm), Weight: M (kg), Moment of inertia: J (kgm²): (4J = MD²)				
Type	Xr	Lr	M	J
LSA 50.2 S4	590	1509	761	16.58
LSA 50.2 M6	632	1609	862	19.05
LSA 50.2 L7	667	1709	932	20.63
LSA 50.2 L8	690	1709	1010	23
LSA 50.2 VL10	736	1809	1120	25.67

NOTE : Dimensions are for information only and may be subject to modifications. Contractual 2D drawings can be downloaded from the Leroy-Somer site, 3D drawing files are available upon request. The torsional analysis of the transmission is imperative. All values are available upon request.

© Nidec 2017. The information contained in this brochure is for guidance only and does not form part of any contract. The accuracy cannot be guaranteed as Nidec have an ongoing process of development and reserve the right to change the specification of their products without notice.

Moteurs Leroy-Somer SAS. Siège : Bd Marcellin Leroy, CS 10015, 16915 Angoulême Cedex 9, France.
Capital social : 65 800 512 €, RCS Angoulême 338 567 258.

4098 en - 2017.12 / g

LEROY-SOMER™

www.leroy-somer.com/epg

[Linkedin.com/company/Leroy-Somer](https://www.linkedin.com/company/Leroy-Somer)
[Twitter.com/Leroy_Somer_en](https://twitter.com/Leroy_Somer_en)
[Facebook.com/LeroySomer.Nidec.en](https://www.facebook.com/LeroySomer.Nidec.en)
[YouTube.com/LeroySomerOfficiel](https://www.youtube.com/LeroySomerOfficiel)

